

Product Catalogue

Household Products

Pressure Boosting pump – Submersible Drainage pump – Submersible Sewage pump –
Submersible Borehole pump – Agricultural/Industrial pump – Deep Well Application –
Hot Water Circulation – Chemical Application



Pressure Boosting

PB Series

Pressure Boosting

Features

- Low noise level
- Automatic operation by precise flow switch
- Steady pressure level

Application

- Water supply and boosting for housing
- Water supply for solar heating system

Downward



PB-088EA



PB-200EA



PB-400EA



PB-S089EA

Technical Data (Downward)

Model	Power Source	Output (W)	Max. Head (m)	Max. Flow Rate (ℓ/min)	Diameter (mm, inch)	Max. Inlet Pressure (bar)	Fluid Temperature ℃ &ℓ
PB-088EA	Single phase 230V 50Hz	80	8	35 (Ht=0.5m)	∅ ∅ ∅ ∅ ∅ ∅	1.2	0 ~ +80
PB-200EA		200	15	55 (Ht=0.5m)	∅ ∅ ∅ ∅ ∅ ∅ ∅ ∅ ∅ ∅ ∅ ∅ ∅ ∅	2	0 ~ +80
PB-201EA		200	15	65 (Ht=0.5m)	∅ ∅ ∅ ∅ ∅	2	0 ~ +80
PB-S125EA		125	11	42(Ht=0.5m)	∅ ∅ ∅ ∅ ∅ ∅	1.5	0 ~ +80
PB-400EA	Single phase 220V 50Hz	400	20	75 (Ht=0.5m)	∅ ∅ ∅ ∅ ∅ ∅ ∅ ∅	2.5	0 ~ +80
PB-H089EA		80	9	40(Ht=0.5m)	∅ ∅ ∅ ∅ ∅ ∅	1.2	0 ~ +100
PB-S089EA		60	8	35 (Ht=0.5m)	∅ ∅ ∅ ∅ ∅ ∅	1.2	0 ~ +80

※PB-S089EA/PB-S125EA: Engineering plastic for wet parts

Upward



PB-250SEA



PB-401SEA

Technical Data (Upward)

Model	Power Source	Output (W)	Max. Head (m)	Rated flow rate (ℓ/min)	Max. Flow Rate (ℓ/min)	Diameter (mm, inch)	Max. Inlet Pressure (bar)	Fluid Temperature ℃ &ℓ
PB-250SEA	Single phase 220V 50Hz	250	19	35 (Ht=12m)	65	∅ ∅ ∅ ∅ ∅	2	0 ~ +60
PB-401SEA		400	21	45 (Ht=12m)	70	∅ ∅ ∅ ∅ ∅ ∅ ∅ ∅	2.5	0 ~ +60

Performance Curve

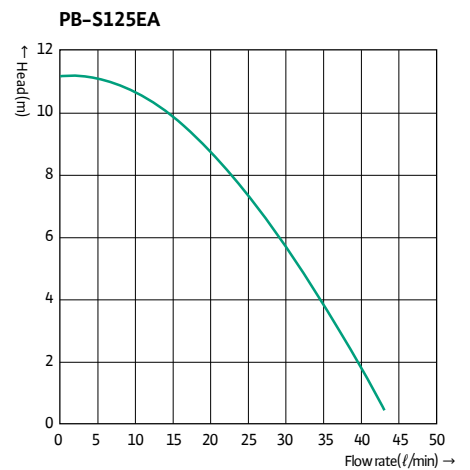
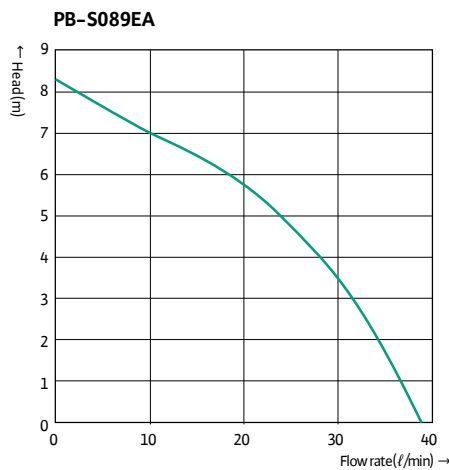
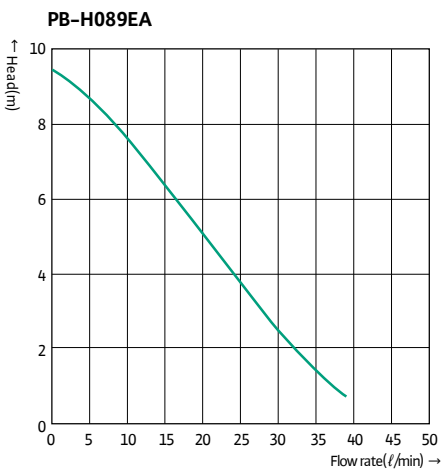
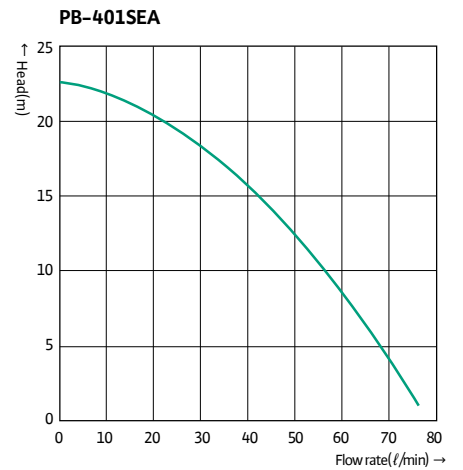
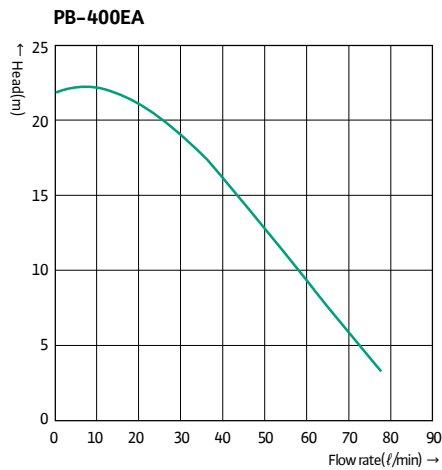
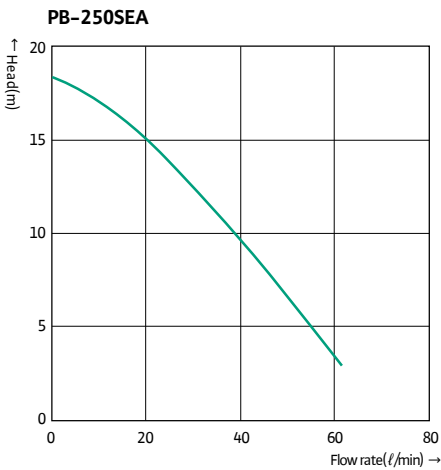
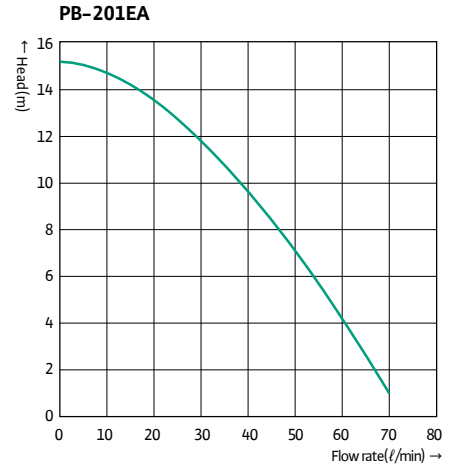
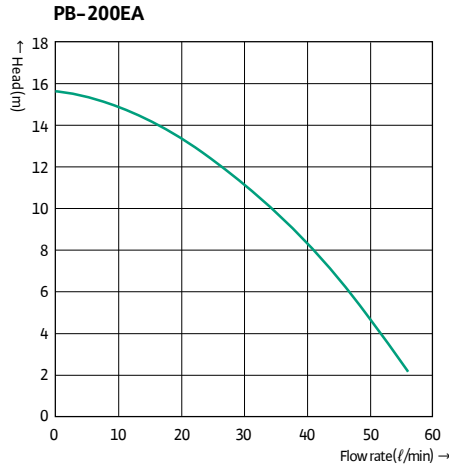
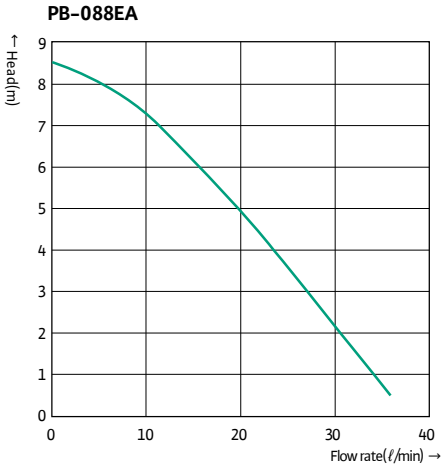

Dimension Drawing

unit : mm

PB-088EA

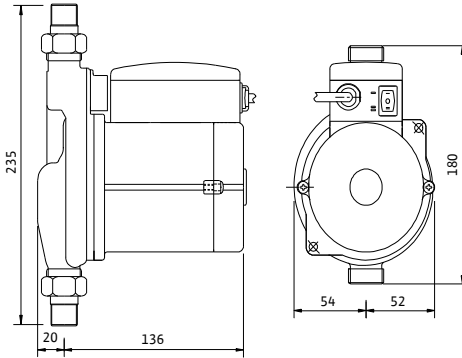

PB-H089EA

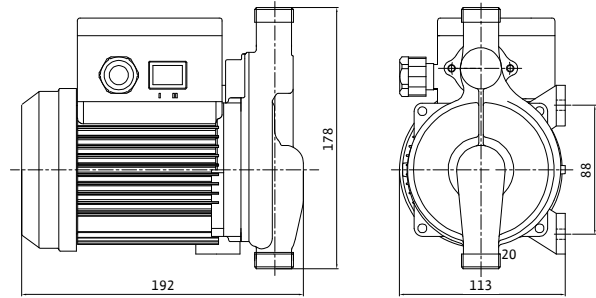

PB-S089EA

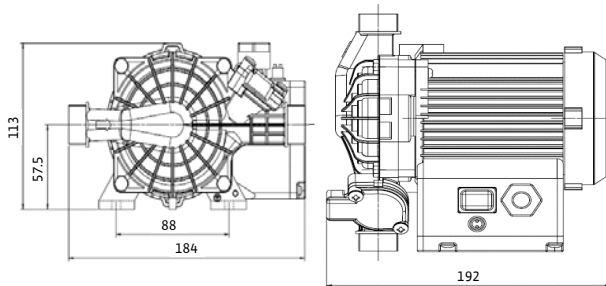

PB-S125EA

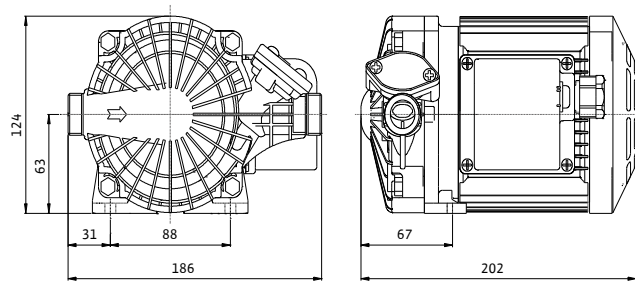

PB-250SEA, PB-401SEA

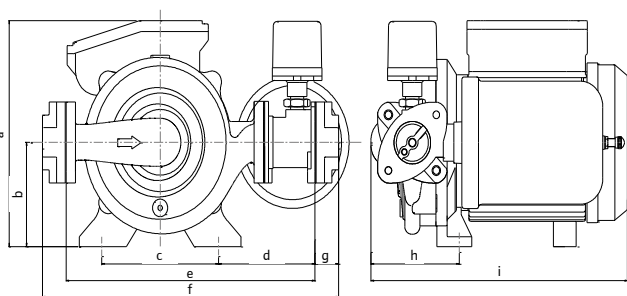

Model	Dimensions(mm)								
	a	b	c	d	e	f	g	h	i
PB- 250SEA	182	86	124	99	260	304	22	97.5	248
PB- 401SEA	207	95	124	103	265	315	25	94	273

PB-200EA, 201EA, 400EA

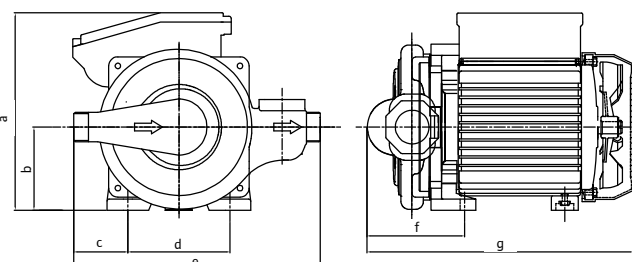

Model	Dimensions(mm)						
	a	b	c	d	e	f	g
PB-200EA	176	74	45	91	220	85	235
PB-201EA	176	74	57	91	240	87	237
PB-400EA	207	95	63	124	270	105	275