

Single impeller centrifugal pump, extremely silent suitable for household, civil and industrial applications, with a very flat curve to guarantee constant pressure at the variation of the flow.

Construction features	
<b>Pump body</b>	cast iron
<b>Motor bracket</b>	cast iron (45, 50, 164÷550); aluminum (75÷100)
<b>Impeller</b>	Noryl® (45) Noryl® or brass (50-314) brass (400-550)
<b>Mechanical seal</b>	ceramic-graphite-NBR
<b>Motor shaft</b>	steel AISI 416 (45÷100) steel AISI 303 (164÷550)
<b>Liquid temperature</b>	Noryl® impeller: 0 - 50 °C brass impeller: 0 - 90 °C
<b>Operating pressure</b>	max 6 bar (45-100) max 8 bar (164-550)

Motor	
	3~ 230/400V-50Hz
<b>2 Poles induction motor</b>	1~ 230V-50Hz (with thermal protection up to MEC 80)
<b>Insulation class</b>	F
<b>Protection degree</b>	IPX4

TYPE	LOTS			
	TRUCK		CONTAINER	
	PALLET (cm)	N° pumps	PALLET (cm)	N° pumps
<b>CM 45-50</b>	80×120×145	102	80×120×190	136
<b>CM 75-100</b>	85×110×145	65	85×110×195	91
<b>CM 164-314</b>	85×110×140	40	85×110×170	60
<b>CM 314 M</b>	85×110×150	24	85×110×180	30
<b>CM 400-550</b>	85×110×150	24	85×110×180	30

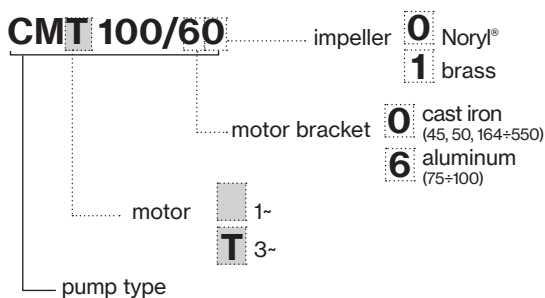

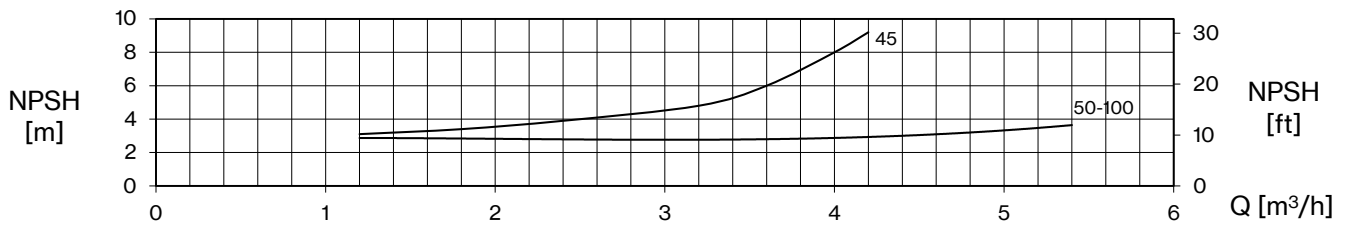
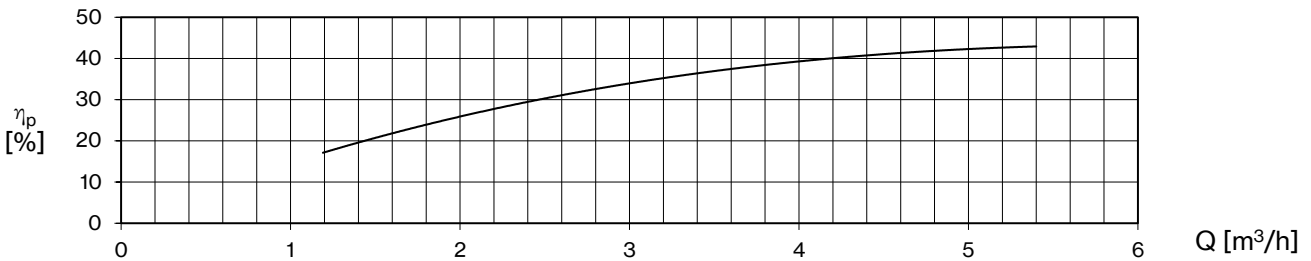
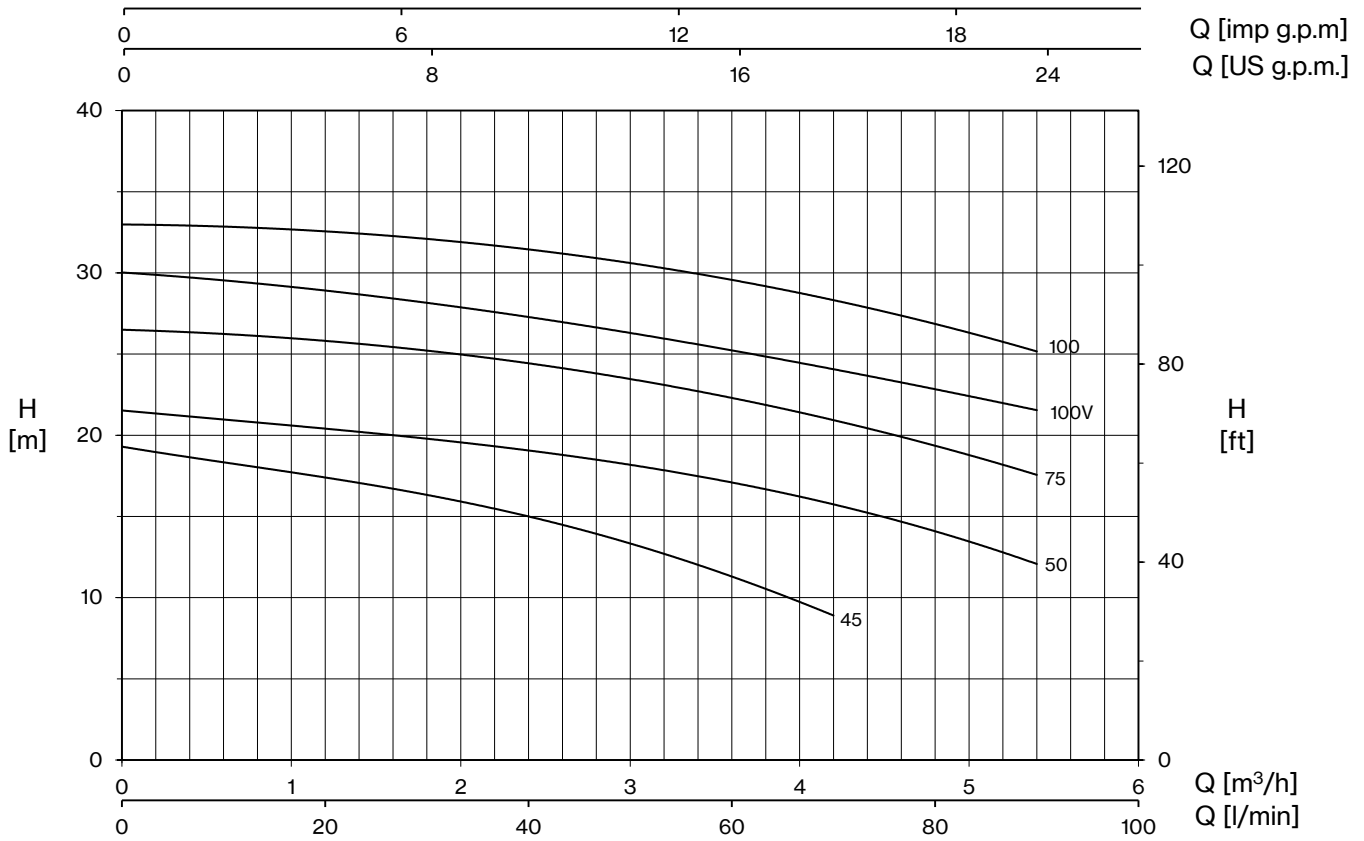

TYPE		P2		P1 (kW)		AMPERE		Q (m³/h - l/min)						
1~	3~	HP	kW	1~	3~	1x230 V 50 Hz	3x400 V 50 Hz	0	1,2	2,4	3,6	4,2	4,8	5,4
								0	20	40	60	70	80	90
								H (m)						
CM 45	CMT 45	0,4	0,3	0,51	0,56	2,3	1,0	19,3	17,4	15,0	11,3	8,9		
CM 50	CMT 50	0,5	0,37	0,59	0,65	2,8	1,1	21,5	20,5	19,0	17,0	15,8	14,2	12,0
CM 75	CMT 75	0,8	0,59	0,9	0,94	4,5	1,7	26,5	25,8	24,5	22,2	20,9	19,5	17,5
CM 100 V	-	1	0,74	1,05	-	4,6	-	30,0	29,0	27,2	25,2	24,1	22,9	21,5
CM 100	CMT 100	1	0,74	1,16	1,17	5,7	2,0	33,0	32,5	31,5	29,6	28,3	26,8	25,2



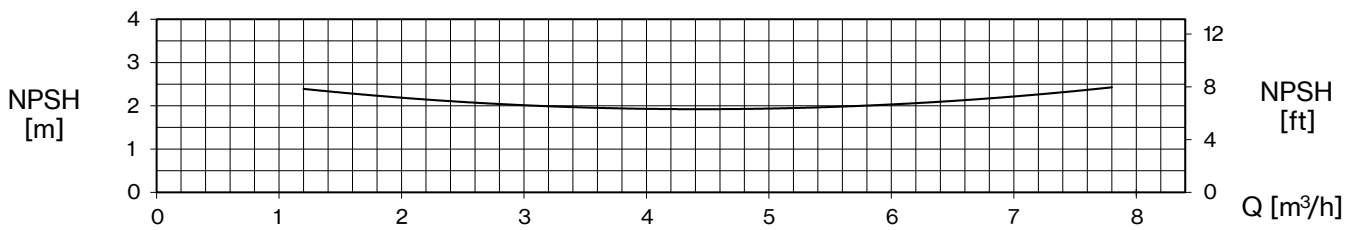
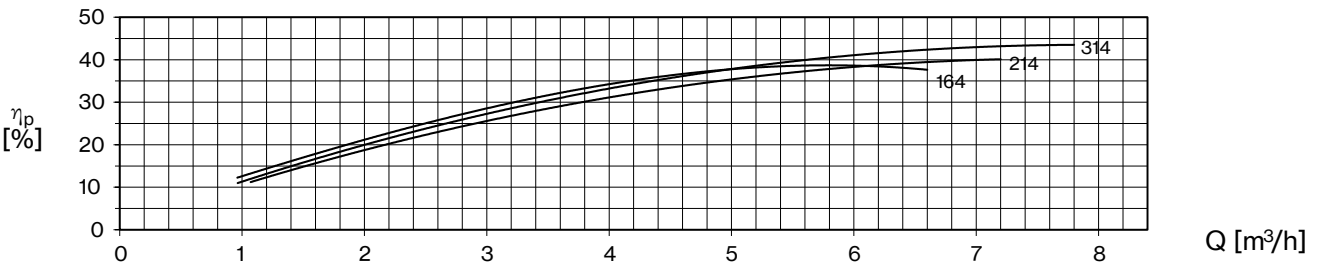
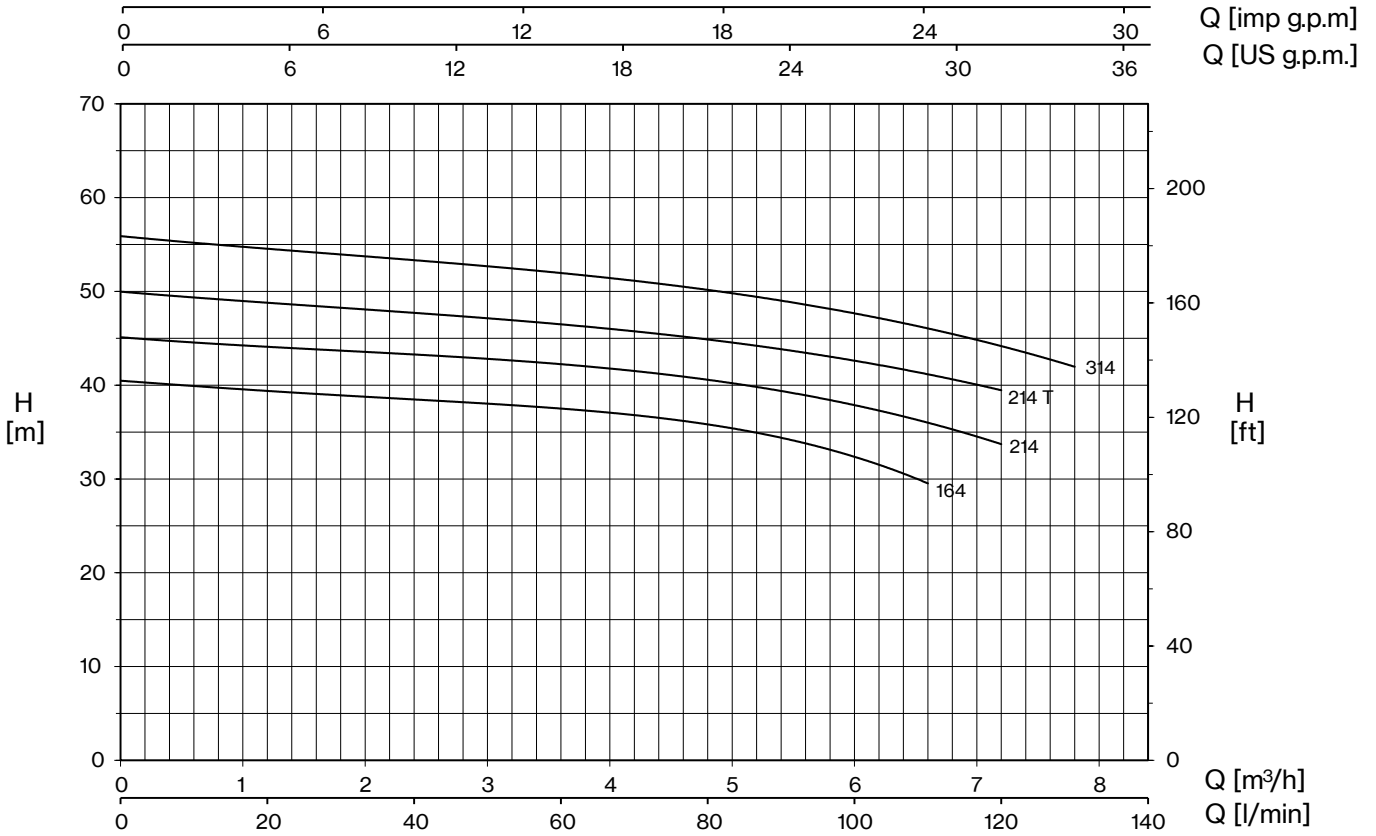

TYPE		P2		P1 (kW)		AMPERE		Q (m³/h - l/min)								
1~	3~					1~	3~	1x230 V 50 Hz	3x400 V 50 Hz	0	1,2	2,4	3,6	4,8	5,4	6,6
		0	20	40	60					80	90	110	120	130		
		HP	kW	1~	3~	H (m)										
CM 164	CMT 164	1,5	1,1	1,9	1,8	8,5	3,4	40,5	39,3	38,6	37,5	35,6	34,6	29,5		
CM 214	-	2	1,5	2,2	-	10,3	-	45,1	44,1	43,3	42,3	40,5	39,2	36,4	33,5	
-	CMT 214	2	1,5	-	2,43	-	4,9	50,0	48,7	47,8	46,5	44,9	43,7	41,3	39,4	
CM 314	CMT 314	3	2,2	2,85	2,67	13,5	5,1	55,9	54,5	53,4	52,0	50,1	48,9	46,2	44,2	41,9



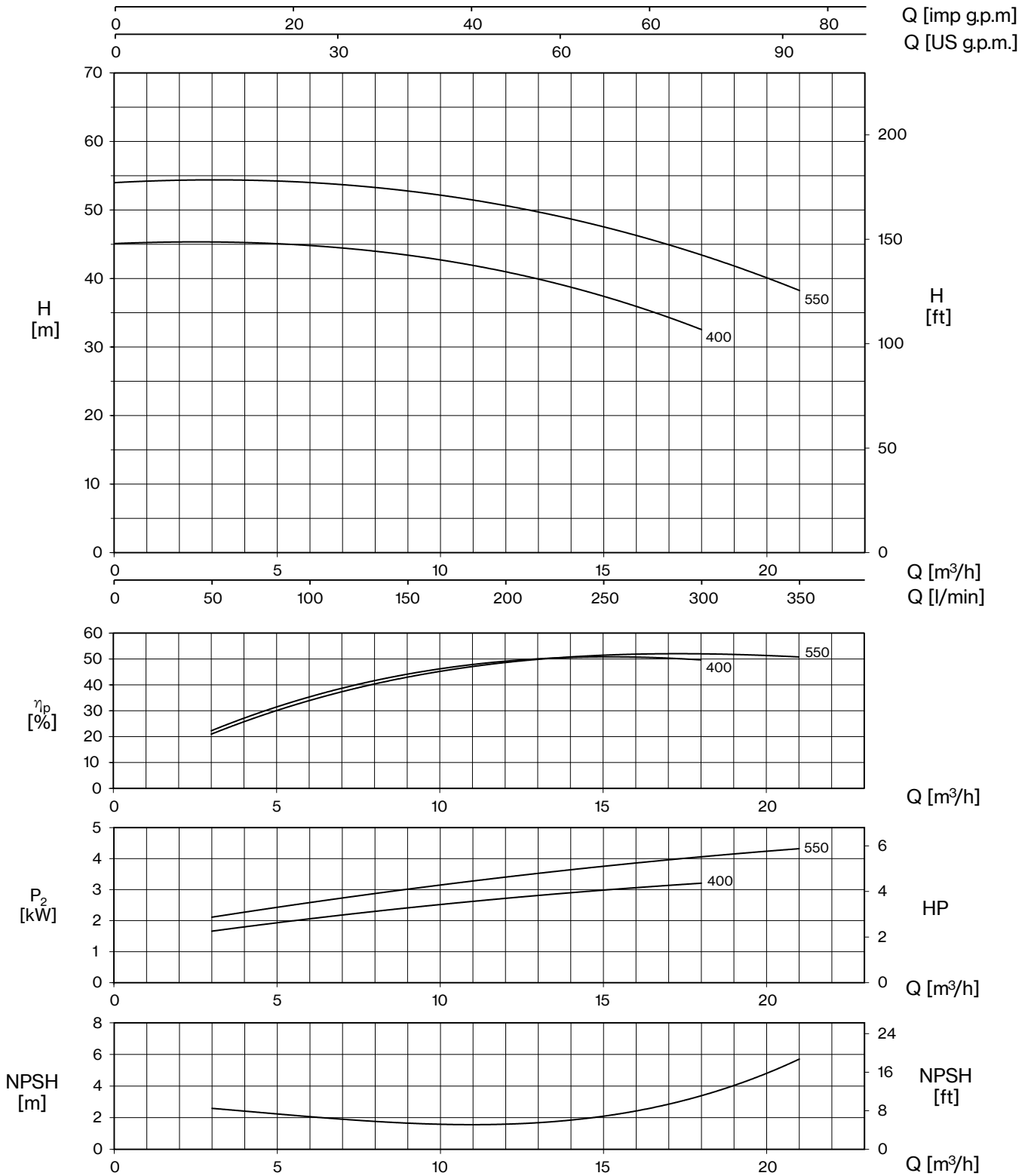

TYPE		P2		P1 (kW)		AMPERE		Q (m³/h - l/min)							
1~	3~	HP	kW	1~	3~	1~ 1x230 V 50 Hz	3~ 3x400 V 50 Hz	0	3	6	9	12	15	18	21
								0	50	100	150	200	250	300	350
								H (m)							
CM 400	CMT 400	4	3	3,6	3,7	16,0	6,7	45,1	45,2	44,9	43,4	40,9	37,4	32,5	
-	CMT 550	5,5	4	-	4,9	-	9,0	54,1	54,1	54,0	52,9	50,7	47,5	43,2	38,4



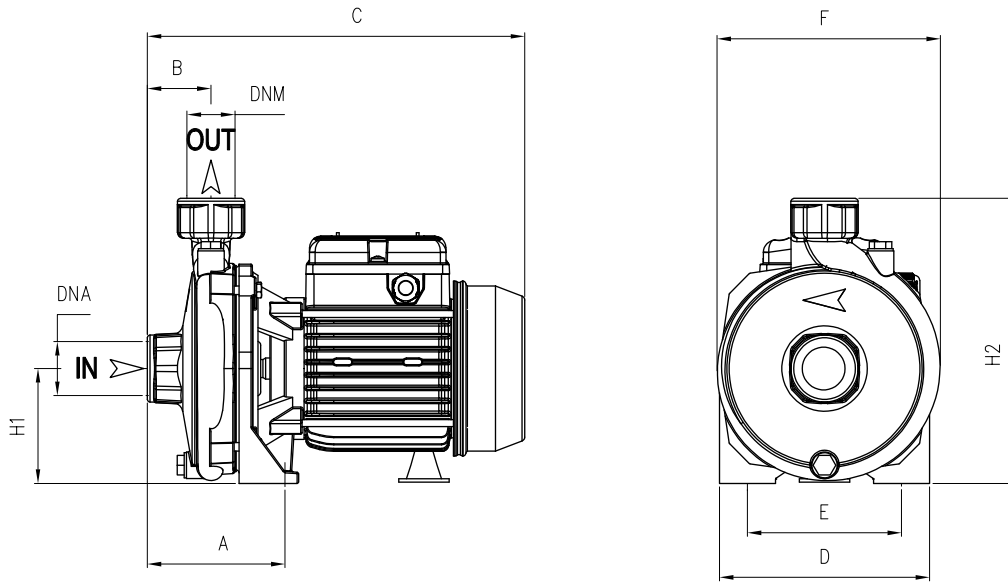

TYPE	DIMENSIONS (mm)														
	A	B	C	D	E	F	H1	H2	DNA	DNM	I	L	M	kg	
CM 45	95	45,5	265	150	110	160	82	202			290	175	225	8,5	
CM 50	95	45,5	265	150	110	160	82	202			290	170	230	9,5	
CM 75	110	46,5	300	180	140	185	97	234	1" G	1" G	325	200	265	13,5	T 13
CM 100 V	110	46,5	300	180	140	185	97	234			325	200	265	14	T 13,5
CM 100	110	46,5	300	180	140	185	97	234			325	200	265	15	T 14,5
CM 164	117	46,5	348	220	180	225	115	285			370	240	315	23	T 22
CM 214	117	46,5	348	220	180	225	115	285	1" ¼ G	1" G	370	240	315	24	T 23
CM 314	117	46,5	M 410	220	180	225	115	285			370	240	315	29	T 23,5
CM 400	108	54	460	240	190	250	133	323	2" G	1" ¼ G	480	255	342	46	T 41,5
CMT 550	108	54	460	240	190	250	133	323			480	255	342	46	T 45,5

