

# ULTRA V/L

Công ty TNHH TBKT An Quảng  
 Hotline: 0901.120122 - 0901.171667 - 0905.468093  
 Địa chỉ: 438 Ông Ích Khiêm - Thanh Khê - Đà Nẵng  
 Email: phucnt@anquang.com - kinhdoanh@anquang.com

Stainless steel multistage vertical pumps. Pumping of clean non-loaded fluids, pressurizing system, irrigation, drinking and glycol water, water treatment, food industry, heating and air conditioning, washing system.



ULTRA V



ULTRA 3-5-7 L

ULTRA 9-18 L



## Construction features

<b>Pump body</b>	cast iron
<b>Motor bracket</b>	cast iron
<b>Impellers, diffusers</b>	Noryl®
<b>Shell, motor shaft</b>	stainless steel AISI 304
<b>Mechanical seal</b>	ceramic-graphite-EPDM graphite-silicon carbide-EPDM
<b>Intermediate shaft guiding stage bush</b>	ceramic-tungsten carbide
<b>Ambient temperature</b>	max 40 °C
<b>Liquid temperature</b>	+5 ÷ +35 °C
<b>Max operating pressure</b>	8 bar ≤ 6 impellers; 14 bar ≥ 7 impellers
<b>Pump body gasket</b>	EPDM

## Motor

<b>2 pole induction motor</b>	3- 230/400V-50Hz P ≤ 4kW
	3- 400/690V-50Hz P > 4kW
	1- 230V-50Hz (with thermal protection up to 1,85 kW)
<b>Insulation class</b>	F
<b>Protection degree</b>	IPX4 IPX5 ≥ 4,5 HP



## U 3 V/ L - 100/5 T

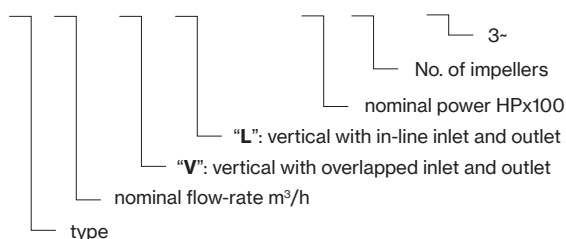

# ULTRA V/L

Công ty TNHH TBKT An Quảng  
 Hotline: 0901.120122 - 0901.171667 - 0905.468093  
 Địa chỉ: 438 Ông Ích Khiêm - Thanh Khê - Đà Nẵng  
 Email: phucnt@anquang.com - kinhdoanh@anquang.com

TYPE		P2		P1 (kW)		AMPERE		Q (m³/h - l/min)						
1-	3-					1-	3-	0	0,6	1,2	1,8	2,4	3,6	4,8
						0	10	20	30	40	60	80		
		HP	kW	1-	3-	1x230 V 50 Hz	3x400 V 50 Hz	H (m)						
U 3...-100/5	U 3...-100/5 T	1	0,75	1,1	1	4,8	1,9	52,2	48,9	45,1	40,8	36,0	25,4	14,0
U 3...-120/6	U 3...-120/6 T	1,2	0,9	1,2	1,2	5,6	2,6	62,8	58,7	54,5	49,6	43,9	32,1	18,3
U 3...-150/7	U 3...-150/7 T	1,5	1,1	1,5	1,5	7,1	2,9	75,5	71,3	66,6	61,2	54,8	41,1	24,9
U 3...-180/8	U 3...-180/8 T	1,8	1,3	1,7	1,6	7,5	3	85,2	80,6	75,1	69,3	61,9	45,2	26,9
U 3...-200/9	U 3...-200/9 T	2	1,5	1,9	1,8	8,4	3,3	95,8	92,2	86,3	78,9	70,7	52,7	30,8
U 3...-250/10	U 3...-250/10 T	2,5	1,8	2,1	2	10	4,1	108,4	102,9	96,5	88,2	79,7	58,3	34,1
U 3...-280/11	U 3...-280/11 T	2,8	2,1	2,3	2,2	10,5	4,3	119,0	112,3	104,4	95,3	85,6	62,7	37,3
U 3...-300/12	U 3...-300/12 T	3	2,2	2,5	2,4	11,2	4,7	128,9	121,5	113,0	103,5	92,2	67,9	40,5

TYPE		P2		P1 (kW)		AMPERE		Q (m³/h - l/min)							
1-	3-					1-	3-	0	1,8	2,4	3,6	4,8	6	7,2	8,4
						0	30	40	60	80	100	120	140		
		HP	kW	1-	3-	1x230 V 50 Hz	3x400 V 50 Hz	H (m)							
U 5...-120/4	U 5...-120/4T	1,2	0,9	1,13	1,13	5,2	2,5	45,3	41,3	39,6	35,6	30,8	24,9	17,6	6,4
U 5...-150/5	U 5...-150/5T	1,5	1,1	1,47	1,39	6,8	2,8	56,8	53,0	51,0	46,1	40,1	33,3	24,8	11,5
U 5...-180/6	U 5...-180/6T	1,8	1,3	1,7	1,62	7,7	3	69,3	64,4	62,0	55,6	48,2	39,6	28,8	12,0
U 5...-200/7	U 5...-200/7T	2	1,5	2,0	1,86	9	3,4	80,3	73,6	71,0	64,5	56,1	46,0	33,4	12,5
U 5...-250/8	U 5...-250/8T	2,5	1,87	2,37	2,17	10,7	4,1	91,4	85,0	81,8	74,3	65,5	54,7	40,4	19,1
U 5...-280/9	U 5...-280/9T	2,8	2,1	2,6	2,4	11,7	4,4	102,1	94,6	90,7	81,6	71,0	58,5	42,3	20,1
U 5...-300/10	U 5...-300/10T	3	2,2	2,84	2,73	12,8	4,9	112,7	103,9	99,9	89,8	78,2	64,0	46,4	21,0
U 5...-350/11	U 5...-350/11T	3,5	2,57	3,0	2,9	13,7	5,3	127,6	122,5	119,4	110,8	98,0	80,8	57,4	
-	U 5...-380/12T	4	3	-	3,2	-	6,0	140,3	135,4	132,1	123,2	109,5	90,1	66,5	

TYPE		P2		P1 (kW)		AMPERE		Q (m³/h - l/min)								
1-	3-					1-	3-	0	2,4	3,6	4,8	6	7,2	8,4	9,6	10,2
						0	40	60	80	100	120	140	160	170		
		HP	kW	1-	3-	1x230 V 50 Hz	3x400 V 50 Hz	H (m)								
U 7...-180/4	U 7...-180/4 T	1,8	1,3	1,83	1,71	8,3	3,2	49,5	47,4	45,3	42,5	39,2	34,8	29,4	22,6	16,9
U 7...-250/5	U 7...-250/5 T	2,5	1,85	2,39	2,15	10,9	4,2	62,6	60,6	58,2	55,1	51,1	45,8	38,9	29,8	21,5
U 7...-300/6	U 7...-300/6 T	3	2,2	2,68	2,63	12,2	5	74,8	71,5	68,3	64,5	59,3	53,0	44,6	34,5	26,7
-	U 7...-350/7 T	3,5	2,57	-	2,8	-	5,1	89,0	88,0	85,8	81,2	74,5	66,3	56,2		
-	U 7...-400/8 T	4	3	-	3,1	-	5,9	102,3	101,0	98,2	92,4	84,4	74,6	62,4		
-	U 7...-450/9 T	4,5	3,37	-	3,6	-	6,5	115,2	114,4	111,4	105,6	97,1	86,3	73,1		
-	U 7...-550/10 T	5,5	4	-	4,0	-	7,7	128,1	128,0	124,9	118,7	109,4	97,6	83,0		

TYPE		P2		P1 (kW)		AMPERE		Q (m³/h - l/min)								
1-	3-					1-	3-	0	3,6	4,8	7,2	9,6	12	13,2	14,4	15,6
						0	60	80	120	160	200	220	240	260		
		HP	kW	1-	3-	1x230 V 50 Hz	3x400 V 50 Hz	H (m)								
U 9...-200/4	U 9...-200/4 T	2	1,5	1,88	1,77	8,4	3,3	47,1	43,5	42,0	38,3	32,4	23,8	18,9	13,3	7,3
U 9...-250/5	U 9...-250/5 T	2,5	1,87	2,32	2,18	10,6	4,3	59,2	54,4	52,4	47,9	40,5	29,8	23,5	16,3	8,5
U 9...-300/6	U 9...-300/6 T	3	2,2	2,74	2,64	12,2	4,8	69,4	63,7	61,4	55,6	46,5	33,5	25,4	17,0	9,0
-	U 9...-400/7 T	4	3	-	3,0	-	5,8	83,3	77,8	75,7	68,9	58,5	43,6	34,7		
-	U 9...-450/8 T	4,5	3,37	-	3,5	-	6,4	96,7	90,7	88,2	80,6	69,2	52,2	42,1		
-	U 9...-500/9 T	4,5	3,37	-	3,9	-	6,9	107,1	99,5	96,4	88,3	75,2	56,4	45,2		
-	U 9...-550/10 T	5,5	4	-	4,3	-	8,1	119,5	111,6	108,2	99,3	84,6	63,5	51,2		



TYPE	P2		P1 (kW)	A	Q (m <sup>3</sup> /h - l/min)										
					3~	0	6	7,2	9,6	12	14,4	16,8	19,2	21,6	24
						0	100	120	160	200	240	280	320	360	400
3~	HP	kW	3~	3x400 V 50 Hz	H (m)										
					U 18...-250/3 T	2,5	1,85	2,19	4,3	34,5	32,0	31,6	30,1	28,1	25,5
U 18...-400/4 T	4	3	3,0	5,8	47,1	45,4	45,2	44,3	42,6	40,0	36,0	30,6	24,6	17,8	
U 18...-450/5 T	4,5	3,37	3,9	6,9	59,2	57,6	57,4	56,4	54,5	51,6	46,7	40,1	33,3	25,3	
U 18...-550/6 T	5,5	4	4,6	8,4	71,4	69,7	69,6	68,2	65,7	62,2	56,3	48,0	39,4	29,4	
U 18...-750/8 T	7,5	5,5	6,2	11,2	96,1	94,2	94,1	92,4	89,1	84,5	77,0	66,1	54,2	41,1	
U 18...-900/9 T	10	7,5	6,9	12,8	108,5	106,9	107,0	105,3	101,7	96,8	88,6	75,9	62,6	47,8	

**ULTRA LG**

TYPE	P2		P1 (kW)	A	Q (m <sup>3</sup> /h - l/min)										
					3~	0	6	7,2	9,6	12	14,4	16,8	19,2	21,6	22,8
						0	100	120	160	200	240	280	320	360	380
3~	HP	kW	3~	3x400 V 50 Hz	H (m)										
					U 18LG-920/10T	10	7,5	7,7	14,0	120,4	116,8	118,3	116,6	112,6	104,4
U 18LG-1000/11T	10	7,5	8,3	13,6	132,4	128,9	130,0	128,0	123,0	115,0	103,9	93,0	72,6	63,4	

**ULTRA V/L**

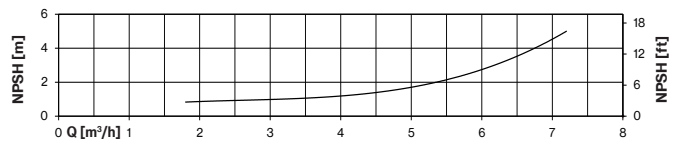
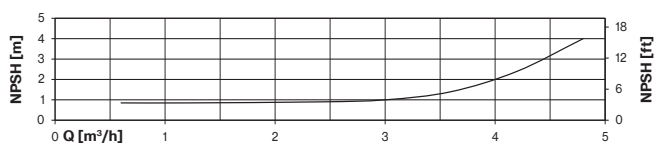
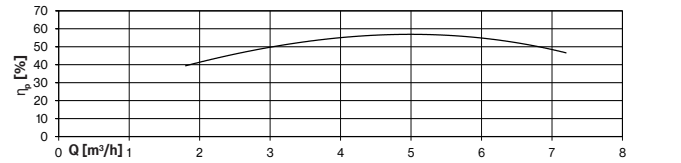
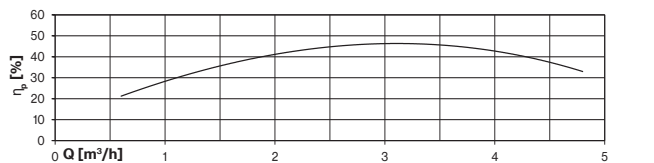
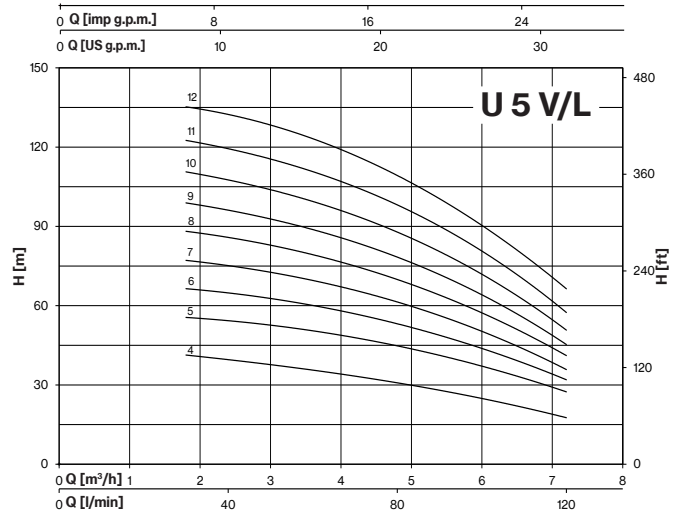
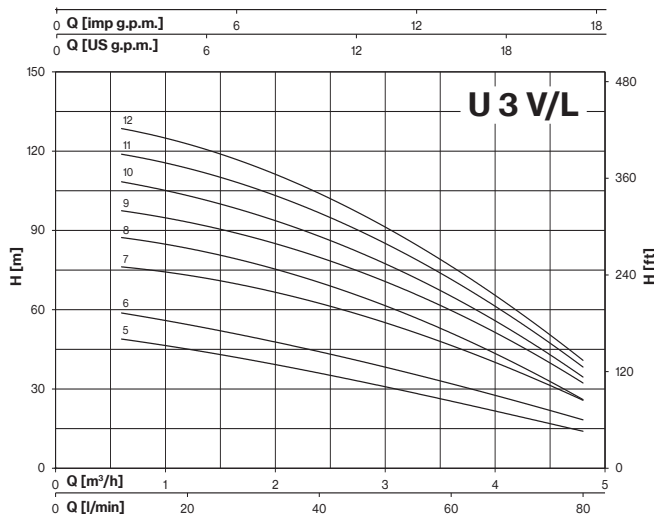

# ULTRA V/L-LG

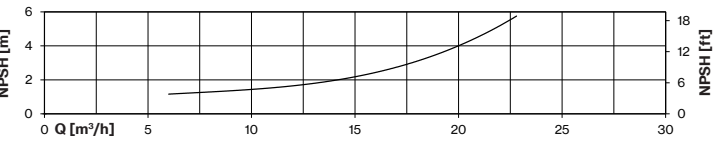
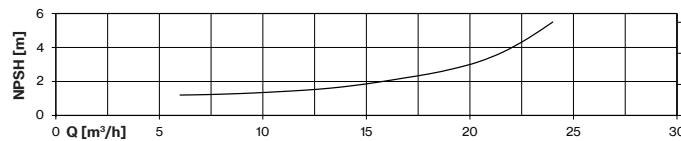
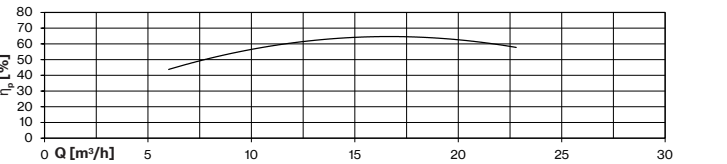
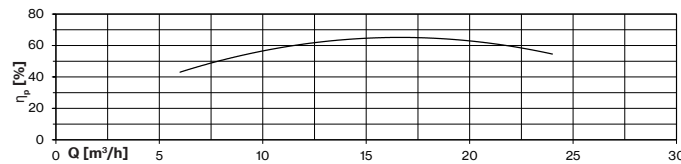
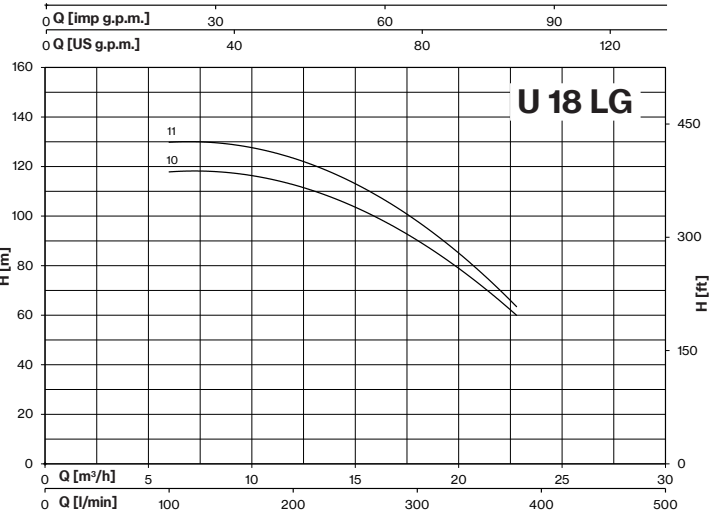
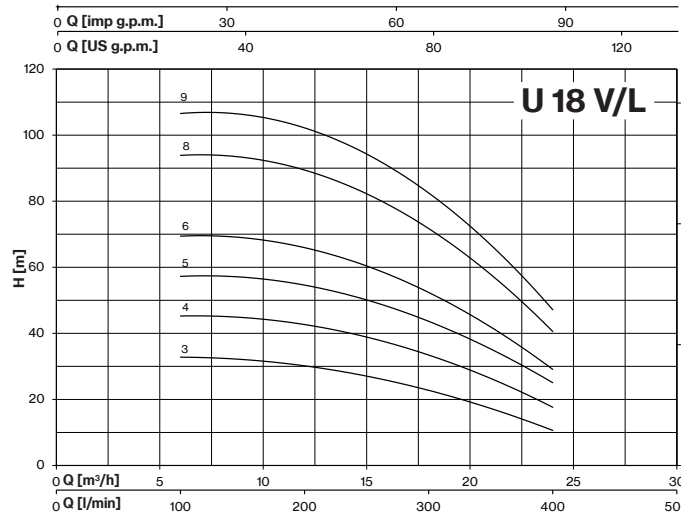
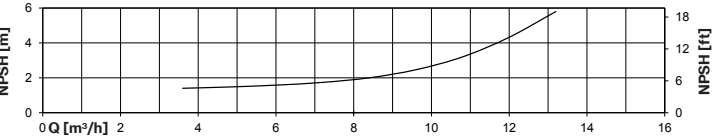
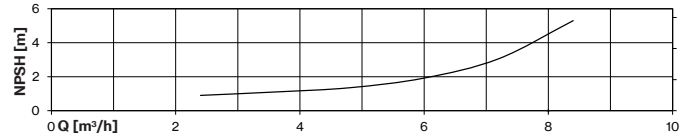
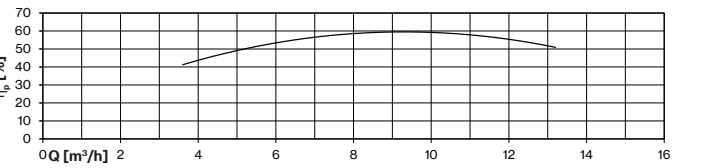
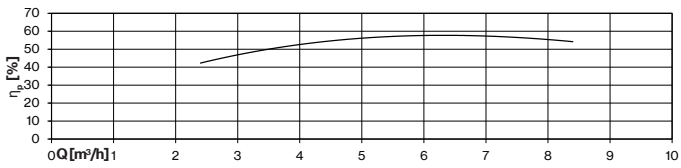
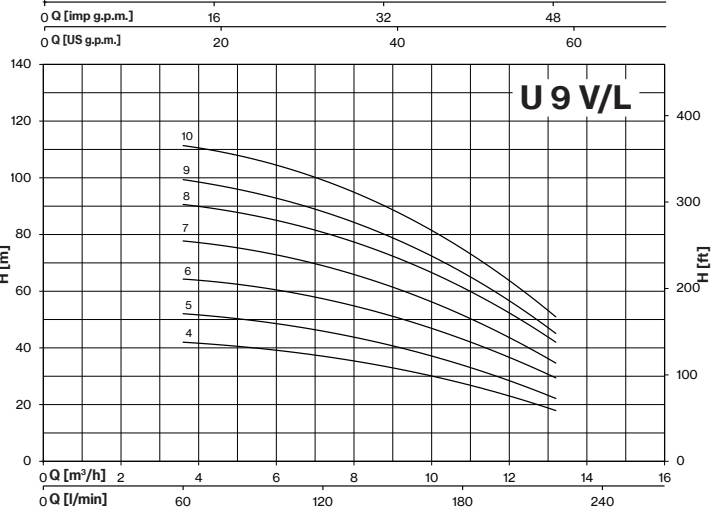
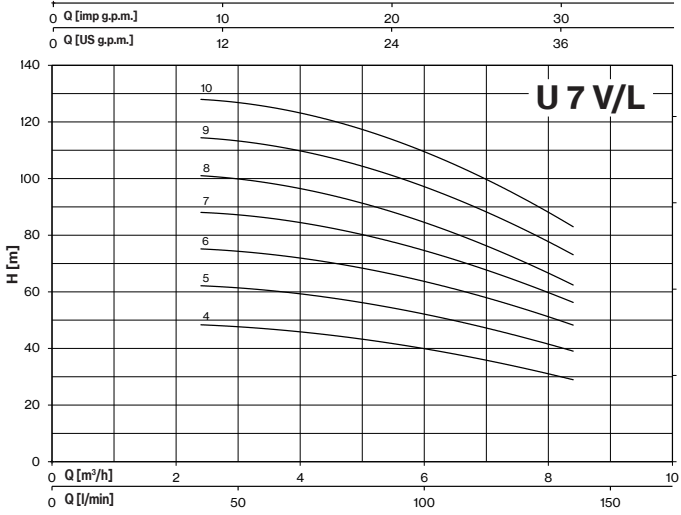

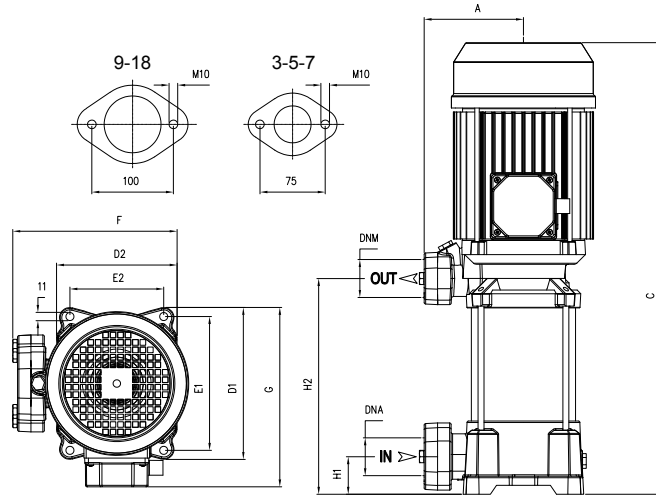

ULTRA V	DIMENSIONS (mm)												Kg			
	A	C	D1	D2	E1	E2	F	G	H1	H2	DNA	DNM				
U 3V-100/5	135	413	204	162	178,5	125	229	213	40	178	1" ¼ G	1" ¼ G	17,5			
U 3V-120/6	135	437	204	162	178,5	125	229	213	40	202			18			
U 3V-150/7	135	521	204	162	178,5	125	229	220	40	226			21   T 20,5			
U 3V-180/8	135	545	204	162	178,5	125	229	220	40	250			22   T 21			
U 3V-200/9	135	569	204	162	178,5	125	229	220	40	274			23   T 22			
U 3V-250/10	135	593	204	162	178,5	125	229	220	40	298			24   T 23			
U 3V-280/11	135	672 T 617	204	162	178,5	125	229	228 T 220	40	322			26   T 23,5			
U 3V-300/12	135	696 T 641	204	162	178,5	125	229	228 T 220	40	346			26,5   T 24			
U 5V-120/4	135	389	204	162	178,5	125	229	213	40	178			1" ¼ G	1" ¼ G	17,5	
U 5V-150/5	135	473	204	162	178,5	125	229	220	40	202					20,5   T 20	
U 5V-180/6	135	497	204	162	178,5	125	229	220	40	226					21,5   20,5	
U 5V-200/7	135	521	204	162	178,5	125	229	220	40	250					22,5   T 21,5	
U 5V-250/8	135	545	204	162	178,5	125	229	220	40	274	23,5   T 22,5					
U 5V-280/9	135	624 T 569	204	162	178,5	125	229	228 T 220	40	298	25,5   T 23					
U 5V-300/10	135	648 T 593	204	162	178,5	125	229	228 T 220	40	322	26   T 24					
U 5V-350/11	135	672	204	162	178,5	125	229	228	40	346	32,5   T 26					
U 5V-380/12	135	696	204	162	178,5	125	229	228	40	370	32,5					
U 7V-180/4	135	422	204	162	178,5	125	229	220	40	178	1" ¼ G	1" ¼ G			21   T 20	
U 7V-250/5	135	473	204	162	178,5	125	229	220	40	202					22,5   T 21,5	
U 7V-300/6	135	552 T 497	204	162	178,5	125	229	228 T 220	40	226					24,5   T 23	
U 7V-350/7	135	575	204	162	178,5	125	229	228	40	250			28			
U 7V-400/8	135	600	204	162	178,5	125	229	228	40	274			31,5			
U 7V-450/9	135	653	204	162	178,5	125	235	243	40	301			35,5			
U 7V-550/10	135	676	204	162	178,5	125	235	243	40	325			42			
U 9V-200/4	135	473	204	162	178,5	125	229	220	40	202			1" ½ G	1" ¼ G	21,5   T 20,5	
U 9V-250/5	135	503	204	162	178,5	125	229	220	40	232					22,5   T 22	
U 9V-300/6	135	588 T 533	204	162	178,5	125	229	228 T 220	40	262					24,5   T 23	
U 9V-400/7	135	617	204	162	178,5	125	229	228	40	292	31,5					
U 9V-450/8	135	677	204	162	178,5	125	235	243	40	325	35,5					
U 9V-500/9	135	707	204	162	178,5	125	235	243	40	355	36					
U 9V-550/10	135	737	204	162	178,5	125	235	243	40	385	40,5					
U 18V-250/3 T	135	481	204	162	178,5	125	229	220	50	211	2" G	1" ½ G			22,5	
U 18V-400/4 T	135	573	204	162	178,5	125	229	228	50	248					31,5	
U 18V-450/5 T	135	640	204	162	178,5	125	235	243	50	289					36,5	
U 18V-550/6 T	135	678	204	162	178,5	125	235	243	50	326			41			
U 18V-750/8 T	135	815	204	162	178,5	125	255	253	50	401			50,5			
U 18V-900/9 T	135	852	204	162	178,5	125	255	253	50	439			57			



# ULTRA L

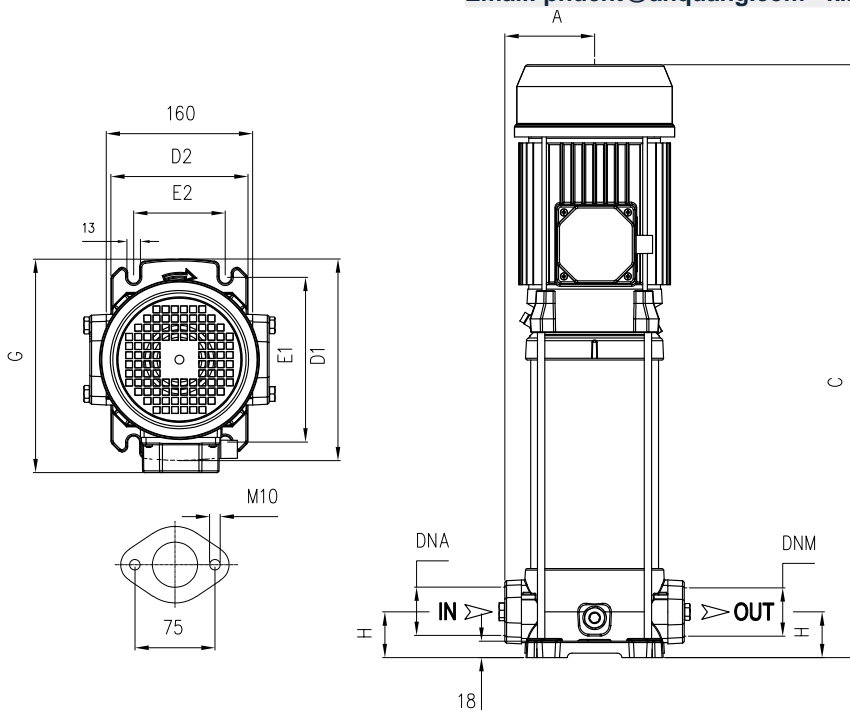

ULTRA L	DIMENSIONS (mm)										Kg				
	A	C	D1	D2	E1	E2	G	H	DNA	DNM					
U 3L-100/5	98	429	220	150	180	100	228	50	1" ¼ G	1" ¼ G	19				
U 3L-120/6	98	453	220	150	180	100	228	50			20				
U 3L-150/7	98	537	220	150	180	100	228	50			23		T 22,5		
U 3L-180/8	98	561	220	150	180	100	228	50			24		T 23		
U 3L-200/9	98	585	220	150	180	100	228	50			25		T 24,5		
U 3L-250/10	98	609	220	150	180	100	228	50			26,5		T 25,5		
U 3L-280/11	98	688 T 633	220	150	180	100	236 T 228	50			28,5		T 26		
U 3L-300/12	98	712 T 657	220	150	180	100	236 T 228	50			28,5		T 27		
U 5L-120/4	98	405	220	150	180	100	221	50			1" ¼ G	1" ¼ G	19,5		T 19
U 5L-150/5	98	489	220	150	180	100	228	50					22,5		T 22
U 5L-180/6	98	513	220	150	180	100	228	50					23,5		T 22,5
U 5L-200/7	98	537	220	150	180	100	228	50					24		T 23,5
U 5L-250/8	98	561	220	150	180	100	228	50	25,5				T 24,5		
U 5L-280/9	98	640 T 585	220	150	180	100	236 T 228	50	27,5				T 25		
U 5L-300/10	98	664 T 609	220	150	180	100	236 T 228	50	28				T 26,5		
U 5L-350/11	98	687	220	150	180	100	236	50	34,5						
U 5L-380/12	98	711	220	150	180	100	236	50	35						
U 7L-180/4	98	465	220	150	180	100	228	50	1" ¼ G	1" ¼ G			23		T 22
U 7L-250/5	98	489	220	150	180	100	228	50					24,5		T 23,5
U 7L-300/6	98	568 T 513	220	150	180	100	236 T 228	50					27		T 25
U 7L-350/7	98	590	220	150	180	100	236	50			30				
U 7L-400/8	98	614	220	150	180	100	236	50			33,5				
U 7L-450/9	98	668	220	150	180	100	251	50			38				
U 7L-550/10	98	692	220	150	180	100	251	50			42,5				



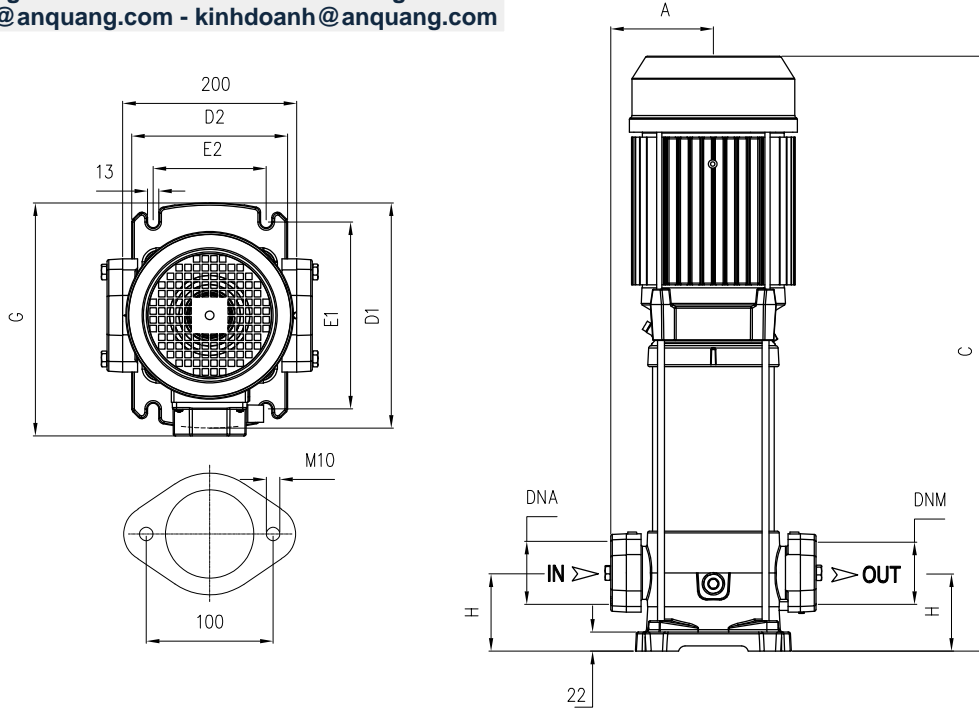

ULTRA L	DIMENSIONS (mm)										Kg	
	A	C	D1	D2	E1	E2	G	H	DNA	DNM		
U 9L-200/4	118	520	260	180	215	130	248	80	1" 1/2 G	1" 1/2 G	28	T 27,5
U 9L-250/5	118	550	260	180	215	130	248	80			29,5	T 28,5
U 9L-300/6	118	635 T 580	260	180	215	130	256 T 248	80			31,5	T 29,5
U 9L-400/7	118	663	260	180	215	130	256	80			38	
U 9L-450/8	118	723	260	180	215	130	271	80			42	
U 9L-500/9	118	763	260	180	215	130	271	80			42	
U 9L-550/10	118	783	260	180	215	130	271	80	47			
U 18L-250/3 T	118	482	260	180	215	130	251	90	2" G	2" G	28,5	
U 18L-400/4 T	118	603	260	180	215	130	257	90			37,5	
U 18L-450/5 T	118	680	260	180	215	130	271	90			41,5	
U 18L-550/6 T	118	718	260	180	215	130	271	90			45,5	
U 18L-750/8 T	118	855	260	180	215	130	280	90			55	
U 18L-900/9 T	118	893	260	180	215	130	280	90			62	

MODEL	LOTS			
	TRUCK		CONTAINER	
	PALLET (cm)	N° pumps	PALLET (cm)	N° pumps
U 3V-100/5-200/9	80x120x150	42	80x120x175	49
U 3V-250/10-300/12	80x120x155	30	80x120x180	35
U 3V-300/12 T	80x120x150	42	80x120x175	49
U 5V-120/4-250/8	80x120x150	42	80x120x175	49
U 5V-280/9 T-300/10 T	80x120x150	42	80x120x175	49
U 5V-280/9-300/10	80x120x155	30	80x120x180	35
U 5V-350/11-380/12 T	80x120x155	30	80x120x180	35
U 7V-180/4-350/7 T	80x120x15	42	80x120x175	49
U 7V-400/8 T	80x120x155	30	80x120x180	35
U 7V-450/9 T-550/10 T	85x110x125	20	85x110x150	24
U 9V-200/4	80x120x150	42	80x120x175	49
U 9V-250/5-300/6 T	80x120x150	42	80x120x175	49
U 9V-300/6 -400/7 T	80x120x155	30	80x120x180	35
U 9V-450/8 T-550/10 T	85x110x125	20	85x110x150	24
U 18V-250/3 T-400/4 T	80x120x150	42	80x120x175	49
U 18V-450/5 T-550/6 T	85x110x125	20	85x110x150	24
U 18V-750/8 T-900/9 T	100x120x150	12	100x120x150	12

MODEL	LOTS			
	TRUCK		CONTAINER	
	PALLET (cm)	N° pumps	PALLET (cm)	N° pumps
U 3L-100/5-180/8	85x110x150	36	85x110x170	42
U 3L-200/9-300/12	80x120x150	30	80x120x170	35
U 5L-120/4-250/8	85x110x150	36	85x110x170	42
U 5L-280/9-380/12 T	80x120x150	30	80x120x170	35
U 7L-180/4-300/6 T	85x110x150	36	85x110x170	42
U 7L-300/6-400/8 T	80x120x150	30	80x120x170	35
U 7L-450/9 T-550/10 T	80x120x150	30	80x120x170	35
U 9L-200/4-400/7 T	80x120x155	25	80x120x185	30
U 9L-450/8 T-550/10 T	85x110x150	20	85x110x150	20
U 18L-250/3 T-400/4 T	80x120x155	25	80x120x185	30
U 18L-450/5 T-550/6 T	85x110x150	20	85x110x150	20
U 18L-750/8 T-900/6 T	85x110x150	20	85x110x150	20



## ULTRA V-SV-L-SL-LG-SLG Serie-Mechanical seal and bearings

MECHANICAL SEAL	PUMP MODEL	SHAFT Ø		STANDARD MATERIAL	OPTIONAL
	U3-100/5, U3-120/6, U5-120/4, U5-150/5, U5-180/6, U7-180/4, U7-250/5, U7-300/6, U9-200/4, U9-250/5, U18-250/3, U18-400/4	14mm / S	<b>Rotating face</b> <b>Stationary face</b> <b>Elastomer</b>	Graphite Ceramic EPDM	SiC SiC EPDM
	U3-150/7, U3-180/8, U3-200/9, U3-250/10, U3-280/11, U3-300/12, U5-200/7, U5-250/8, U5-280/9, U5-300/10, U5-350/11, U5-380/12, U7-350/7, U7-400/8, U7-450/9, U7-550/10, U9-300/6, U9-400/7, U9-450/8, U9-500/9, U9-550/10	14mm	<b>Rotating face</b> <b>Stationary face</b> <b>Elastomer</b>	Graphite SiC EPDM	SiC SiC EPDM
	U18-450/5, U18-550/6, U18-750/8, U18-900/9, U18-920/10, U18-1000/11	14mm / L	<b>Rotating face</b> <b>Stationary face</b> <b>Elastomer</b>	Graphite SiC EPDM	SiC SiC EPDM
	U3-350/14, U3-380/16, U3-400/18, U3-450/20, U5-400/14, U5-450/16, U5-550/18, U5-600/20, U7-750/12, U7-800/14, U7-900/16, U7-950/18, U7-1000/20, U9-750/12, U9-800/14, U9-900/16, U9-950/18, U9-1000/20	14mm / Balanced seal	<b>Rotating face</b> <b>Stationary face</b> <b>Elastomer</b>	Tungsten carbide Graphite EPDM	- - -

BEARINGS	PUMP MODEL	TYPE	
	U3-100/5, U3-120/6, U5-120/4	6202-ZZ	6302-ZZ C3
	U3-150/7, U3-180/8, U3-200/9, U3-250/10, 3- U3-280/11, 3- U3-300/12, U5-150/5, U5-180/6, U5-200/7, U5-250/8, 3- U5-280/9, 3- U5-300/10, U7-180/4, U7-250/5, 3- U7-300/6, U9-200/4, U9-250/5, 3- U9-300/6, U18-250/3	6204-ZZ	6304-ZZ C3
	1- U3-280/11, 1- U3-300/12, 1- U5-280/9, 1- U5-300/10, U5-350/11, U5-380/12, 1- U7-300/6, U7-350/7, U7-400/8, 1- U9-300/6, U9-400/7, U18-400/4, U3-350/14, U3-380/16, U3-400/18, U5-400/14	6203-ZZ	6305-ZZ C3
	U7-450/9, U7-550/10, U9-450/8, U9-500/9, U9-550/10, U18-450/5, U18-550/6	6204-ZZ	6306-ZZ-C3
	U3-450/20, U5-450/16, U5-550/18, U5-600/20	6204-ZZ	3206-ZZ C3
	U7-750/12, U7-800/14, U7-900/16, U9-750/12, U9-800/14, U9-900/16, U18-750/8, U18-900/9, U18-920/10	6206-ZZ C3	3306-ZZ C3
	U7-950/18, U7-1000/20, U9-950/18, U9-1000/20, U18-1000/11	6206-ZZ C3	3308-ZZ C3

# ULTRA+VSD

Công ty TNHH TBKT An Quảng  
Hotline: 0901.120122 - 0901.171667 - 0905.468093  
Địa chỉ: 438 Ông Ích Khiêm - Thanh Khê - Đà Nẵng  
Email: phucnt@anquang.com - kinhdoanh@anquang.com

Vertical booster pump with variable speed



## DESCRIPTION

Horizontal pump of ULTRA series provided with variable speed drive EPIC or IPFC. This booster pump assure the desired pressure regardless changes on flow demand making it suitable for low or missing pressure in residential systems and industrial applications. It is required the installation of a membrane tank downstream the system.

## FEATURES

- EPIC or IPFC variable speed drive
- Vertical pump of ULTRA series
- Pressure sensor wired to the vsd
- Cable with plug for EPIC vsd only

## FUNCTIONING

If the pressure in the network drops the pump will starts and gradually speeds up to provide with the set pressure. When the water demand decreases, the pressure will rise causing the pump speed to slow down and eventually to stop the pump if demand ceases. The pump will remain on standby waiting to start at the next water demand.

## SELECTION

The table below shows the vertical ULTRA pump models available for the assembly with EPIC or IPFC. Consult the catalog at the ULTRA series for pump specifics and characteristic curves.



PUMP								VSD		
TYPE	MODEL	Version						TYPE	Power system	
		V	SV	L	SL/SLX	LG	SLG/SLGX		in	out
U 3	100/5T	■	■	■	■	-	-	EPIC	1-230	3-230
		■	■	■	■	-	-	IPFC109	1-230	3-230
		■	■	■	■	-	-	IPFC306	3-400	3-400
	120/6T	■	■	■	■	-	-	EPIC	1-230	3-230
		■	■	■	■	-	-	IPFC109	1-230	3-230
		■	■	■	■	-	-	IPFC306	3-400	3-400
	150/7T	■	■	■	■	-	-	EPIC	1-230	3-230
		■	■	■	■	-	-	IPFC109	1-230	3-230
		■	■	■	■	-	-	IPFC306	3-400	3-400
	180/8T	■	■	■	■	-	-	EPIC	1-230	3-230
		■	■	■	■	-	-	IPFC109	1-230	3-230
		■	■	■	■	-	-	IPFC306	3-400	3-400
	200/9T	■	■	■	■	-	-	EPIC	1-230	3-230
		■	■	■	■	-	-	IPFC109	1-230	3-230
		■	■	■	■	-	-	IPFC306	3-400	3-400
	250/10T	■	■	■	■	-	-	EPIC	1-230	3-230
■		■	■	■	-	-	IPFC114	1-230	3-230	
■		■	■	■	-	-	IPFC306	3-400	3-400	
280/11T	-	■	-	■	-	-	EPIC	1-230	3-230	
	■	■	■	■	-	-	IPFC114	1-230	3-230	
	■	■	■	■	-	-	IPFC306	3-400	3-400	
300/12T	■	■	■	■	-	-	IPFC114	1-230	3-230	
	■	■	■	■	-	-	IPFC306	3-400	3-400	
350/14T	-	-	-	-	-	■	IPFC114	1-230	3-230	
	-	-	-	-	-	■	IPFC306	3-400	3-400	
380/16T	-	-	-	-	-	■	IPFC114	1-230	3-230	
	-	-	-	-	-	■	IPFC309	3-400	3-400	
400/18T	-	-	-	-	-	■	IPFC309	3-400	3-400	
450/20T	-	-	-	-	-	■	IPFC309	3-400	3-400	
U 5	120/4T	■	■	■	■	-	-	EPIC	1-230	3-230
		■	■	■	■	-	-	IPFC109	1-230	3-230
		■	■	■	■	-	-	IPFC306	3-400	3-400
	150/5T	■	■	■	■	-	-	EPIC	1-230	3-230
		■	■	■	■	-	-	IPFC109	1-230	3-230
		■	■	■	■	-	-	IPFC306	3-400	3-400
	180/6T	■	■	■	■	-	-	EPIC	1-230	3-230
		■	■	■	■	-	-	IPFC109	1-230	3-230
		■	■	■	■	-	-	IPFC306	3-400	3-400
	200/7T	■	■	■	■	-	-	EPIC	1-230	3-230
		■	■	■	■	-	-	IPFC109	1-230	3-230
		■	■	■	■	-	-	IPFC306	3-400	3-400
	250/8T	■	■	■	■	-	-	EPIC	1-230	3-230
		■	■	■	■	-	-	IPFC114	1-230	3-230
		■	■	■	■	-	-	IPFC306	3-400	3-400
	280/9T	■	■	■	■	-	-	IPFC114	1-230	3-230
■		■	■	■	-	-	IPFC306	3-400	3-400	
300/10T	■	■	■	■	-	-	IPFC114	1-230	3-230	
	■	■	■	■	-	-	IPFC306	3-400	3-400	
350/11T	■	■	■	■	-	-	IPFC114	1-230	3-230	
	■	■	■	■	-	-	IPFC306	3-400	3-400	
380/12T	■	■	■	■	-	-	IPFC309	3-400	3-400	
400/14T	-	-	-	-	-	■	IPFC309	3-400	3-400	
450/16T	-	-	-	-	-	■	IPFC309	3-400	3-400	
550/18T	-	-	-	-	-	■	IPFC309	3-400	3-400	
600/20T	-	-	-	-	-	■	IPFC311	3-400	3-400	



## ULTRA+VSD

		PUMP						VSD		
TYPE	MODEL	Version						TYPE	Power system	
		V	SV	L	SL/SLX	LG	SLG/SLGX		in	out
U 7	180/4T	■	■	■	■	-	-	EPIC	1-230	3-230
		■	■	■	■	-	-	IPFC109	1-230	3-230
		■	■	■	■	-	-	IPFC306	3-400	3-400
	250/5T	■	■	■	■	-	-	IPFC114	1-230	3-230
		■	■	■	■	-	-	IPFC306	3-400	3-400
	300/6T	■	■	■	■	-	-	IPFC114	1-230	3-230
		■	■	■	■	-	-	IPFC306	3-400	3-400
	350/7T	■	■	■	■	-	-	IPFC114	1-230	3-230
		■	■	■	■	-	-	IPFC306	3-400	3-400
	400/8T	■	■	■	■	-	-	IPFC309	3-400	3-400
	450/9T	■	■	■	■	-	-	IPFC309	3-400	3-400
	550/10T	■	■	■	■	-	-	IPFC311	3-400	3-400
	750/12T	-	-	-	-	-	■	IPFC311	3-400	3-400
800/14T	-	-	-	-	-	■	IPFC314	3-400	3-400	
900/16T	-	-	-	-	-	■	IPFC314	3-400	3-400	
950/18T	-	-	-	-	-	■	IPFC318	3-400	3-400	
1000/20T	-	-	-	-	-	■	IPFC318	3-400	3-400	
U 9	200/4T	■	■	■	■	-	-	EPIC	1-230	3-230
		■	■	■	■	-	-	IPFC109	1-230	3-230
		■	■	■	■	-	-	IPFC306	3-400	3-400
	250/5T	■	■	■	■	-	-	EPIC	1-230	3-230
		■	■	■	■	-	-	IPFC114	1-230	3-230
	300/6T	■	■	■	■	-	-	IPFC306	3-400	3-400
		■	■	■	■	-	-	IPFC114	1-230	3-230
	400/7T	■	-	■	-	-	-	IPFC306	3-400	3-400
		-	-	-	■	-	-	IPFC309	3-400	3-400
	450/8T	■	■	■	■	-	-	IPFC309	3-400	3-400
	500/9T	■	■	■	■	-	-	IPFC309	3-400	3-400
	550/10T	■	■	■	■	-	-	IPFC311	3-400	3-400
	750/12T	-	-	-	-	-	■	IPFC311	3-400	3-400
800/14T	-	-	-	-	-	■	IPFC314	3-400	3-400	
900/16T	-	-	-	-	-	■	IPFC314	3-400	3-400	
950/18T	-	-	-	-	-	■	IPFC318	3-400	3-400	
1000/20T	-	-	-	-	-	■	IPFC318	3-400	3-400	



PUMP									VSD		
TYPE	MODEL	Version							TYPE	Power system	
		V	SV	L	SL/SLX	LG	HS	HX		in	out
U 18	100/1T	-	-	-	-	-	-	■	IPFC109	1-230	3-230
		-	-	-	-	-	-	■	IPFC306	3-400	3-400
	200/2T	-	-	-	-	-	-	■	IPFC109	1-230	3-230
		-	-	-	-	-	-	■	IPFC306	3-400	3-400
	250/3T	■	■	■	■	-	-	-	EPIC	1-230	3-230
		■	■	■	■	-	-	-	IPFC114	1-230	3-230
		■	■	■	■	-	-	-	IPFC306	3-400	3-400
	300/3T	-	-	-	-	-	-	■	IPFC114	1-230	3-230
		-	-	-	-	-	-	■	IPFC306	3-400	3-400
	400/4T	■	■	■	■	-	-	■	IPFC114	1-230	3-230
		■	■	■	■	-	-	■	IPFC306	3-400	3-400
	450/5T	■	■	■	■	-	-	-	IPFC309	3-400	3-400
	550/5T	-	-	-	-	-	-	■	IPFC309	3-400	3-400
	550/6T	■	■	■	■	-	-	-	IPFC311	3-400	3-400
	750/6T	-	-	-	-	-	-	■	IPFC311	3-400	3-400
	750/7T	-	-	-	-	-	-	■	IPFC311	3-400	3-400
	750/8T	■	■	■	■	-	-	-	IPFC314	3-400	3-400
	900/9T	■	■	■	■	-	-	-	IPFC318	3-400	3-400
	920/10T	-	-	-	-	■	-	-	IPFC318	3-400	3-400
	1000/8T	-	-	-	-	-	-	■	IPFC314	3-400	3-400
	1000/9T	-	-	-	-	-	-	■	IPFC314	3-400	3-400
	1000/11T	-	-	-	-	■	-	-	IPFC318	3-400	3-400
1500/10T	-	-	-	-	-	-	■	IPFC318	3-400	3-400	
1500/11T	-	-	-	-	-	-	■	IPFC318	3-400	3-400	
1500/12T	-	-	-	-	-	-	■	IPFC325	3-400	3-400	
1500/13T	-	-	-	-	-	-	■	IPFC325	3-400	3-400	
1500/14T	-	-	-	-	-	-	■	IPFC325	3-400	3-400	
2000/15T	-	-	-	-	-	-	■	IPFC325	3-400	3-400	
2000/16T	-	-	-	-	-	-	■	IPFC325	3-400	3-400	
2000/17T	-	-	-	-	-	-	■	IPFC330	3-400	3-400	
U 22	200/1T	-	-	-	-	-	-	■	IPFC109	1-230	3-230
		-	-	-	-	-	-	■	IPFC306	3-400	3-400
	300/2T	-	-	-	-	-	-	■	IPFC114	1-230	3-230
		-	-	-	-	-	-	■	IPFC306	3-400	3-400
	400/3T	-	-	-	-	-	-	■	IPFC309	3-400	3-400
	550/4T	-	-	-	-	-	-	■	IPFC311	3-400	3-400
	750/5T	-	-	-	-	-	-	■	IPFC311	3-400	3-400
	1000/6T	-	-	-	-	-	-	■	IPFC314	3-400	3-400
	1000/7T	-	-	-	-	-	-	■	IPFC318	3-400	3-400
	1500/8T	-	-	-	-	-	-	■	IPFC318	3-400	3-400
	1500/9T	-	-	-	-	-	-	■	IPFC325	3-400	3-400
	1500/10T	-	-	-	-	-	-	■	IPFC325	3-400	3-400
	2000/11T	-	-	-	-	-	-	■	IPFC325	3-400	3-400
	2000/12T	-	-	-	-	-	-	■	IPFC325	3-400	3-400
2000/13T	-	-	-	-	-	-	■	IPFC330	3-400	3-400	
2000/14T	-	-	-	-	-	-	■	IPFC330	3-400	3-400	



# ULTRA+VSD

Công ty TNHH TBKT An Quảng  
 Hotline: 0901.120122 - 0901.171667 - 0905.468093  
 Địa chỉ: 438 Ông Ích Khiêm - Thanh Khê - Đà Nẵng  
 Email: phucnt@anquang.com - kinhdoanh@anquang.com

		PUMP							VSD		
TYPE	MODEL	Version							TYPE	Power system	
		V	SV	L	SL/SLX	LG	HS	HX		in	out
U 35	300/1T	-	-	-	-	-	■	■	IPFC114	1-230	3-230
		-	-	-	-	-	■	■	IPFC306	3-400	3-400
	550/2-2RT	-	-	-	-	-	■	■	IPFC309	3-400	3-400
	550/2-1RT	-	-	-	-	-	■	■	IPFC309	3-400	3-400
	750/2T	-	-	-	-	-	■	■	IPFC311	3-400	3-400
	750/3-2RT	-	-	-	-	-	■	■	IPFC311	3-400	3-400
	1000/3-1RT	-	-	-	-	-	■	■	IPFC314	3-400	3-400
	1000/3T	-	-	-	-	-	■	■	IPFC314	3-400	3-400
	1000/4-2RT	-	-	-	-	-	■	■	IPFC318	3-400	3-400
	1500/4-1RT	-	-	-	-	-	■	■	IPFC318	3-400	3-400
	1500/4T	-	-	-	-	-	■	■	IPFC325	3-400	3-400
	1500/5-2RT	-	-	-	-	-	■	■	IPFC325	3-400	3-400
	1500/5-1RT	-	-	-	-	-	■	■	IPFC325	3-400	3-400
	2000/5T	-	-	-	-	-	■	■	IPFC325	3-400	3-400
	2000/6-2RT	-	-	-	-	-	■	■	IPFC325	3-400	3-400
	2000/6-1RT	-	-	-	-	-	■	■	IPFC330	3-400	3-400
	2000/6T	-	-	-	-	-	■	■	IPFC330	3-400	3-400
2000/7-2RT	-	-	-	-	-	■	■	IPFC330	3-400	3-400	
2000/7-1RT	-	-	-	-	-	■	■	IPFC330	3-400	3-400	
U 50	400/1-1RT	-	-	-	-	-	■	■	IPFC114	1-230	3-230
		-	-	-	-	-	■	■	IPFC306	3-400	3-400
	550/1T	-	-	-	-	-	■	■	IPFC309	3-400	3-400
	750/2-2RT	-	-	-	-	-	■	■	IPFC311	3-400	3-400
	1000/2T	-	-	-	-	-	■	■	IPFC318	3-400	3-400
	1500/3-2RT	-	-	-	-	-	■	■	IPFC325	3-400	3-400
	1500/3T	-	-	-	-	-	■	■	IPFC318	3-400	3-400
	2000/4-2RT	-	-	-	-	-	■	■	IPFC325	3-400	3-400
2000/4T	-	-	-	-	-	■	■	IPFC330	3-400	3-400	
U 75	550/1-1RT	-	-	-	-	-	■	■	IPFC309	3-400	3-400
	750/1T	-	-	-	-	-	■	■	IPFC311	3-400	3-400
	1000/2-2RT	-	-	-	-	-	■	■	IPFC318	3-400	3-400
	1500/2-1RT	-	-	-	-	-	■	■	IPFC318	3-400	3-400
	1500/2T	-	-	-	-	-	■	■	IPFC325	3-400	3-400
	2000/3-2RT	-	-	-	-	-	■	■	IPFC325	3-400	3-400
	2000/3-1RT	-	-	-	-	-	■	■	IPFC330	3-400	3-400
U 90	750/1-1RT	-	-	-	-	-	■	■	IPFC311	3-400	3-400
	1000/1T	-	-	-	-	-	■	■	IPFC318	3-400	3-400
	1500/2-2RT	-	-	-	-	-	■	■	IPFC325	3-400	3-400
	2000/2T	-	-	-	-	-	■	■	IPFC330	3-400	3-400

