



Single-impeller, medium to high-flow rate centrifugal pumps with 2", 3" and 4" delivery openings. Mainly used in agriculture for flood and sprinkler irrigation, and water withdrawal from reservoirs or canals.

Construction features

Pump body	cast iron
Motor bracket	cast iron
Impeller	cast iron or brass (CSB)
Mechanical seal	ceramic-graphite-NBR
Motor shaft	stainless steel AISI 303 stainless steel AISI 416 (75÷120)
Liquid temperature	0 - 90 °C
Operating pressure	max 6 bar

Motor

	3- 230/400V-50Hz
2 Poles induction motor	1- 230V-50Hz (with thermal protection up to MEC 80)
Insulation class	F
Protection degree	IPX4

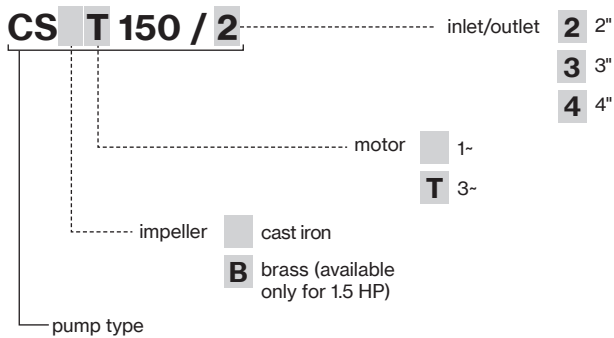

TYPE	LOTS			
	TRUCK		CONTAINER	
	PALLET (cm)	N° pumps	PALLET (cm)	N° pumps
CS 75/2-120/2	90×110×145	65	90×110×195	91
CS 150/2-200/2	85×110×140	40	85×110×205	60
CS 200/3-300/3	85×110×150	30	85×110×180	60
CS 400/4-550/4	80×120×150	30	80×120×180	60
CST 750/4-1000/4	100×120×140	18	100×120×185	24

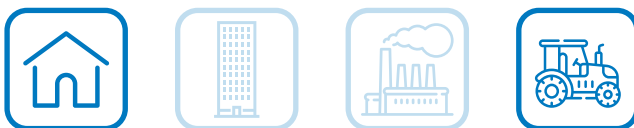

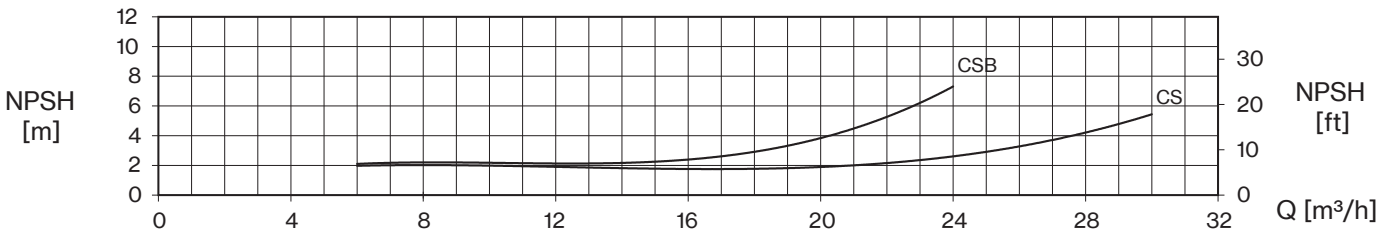
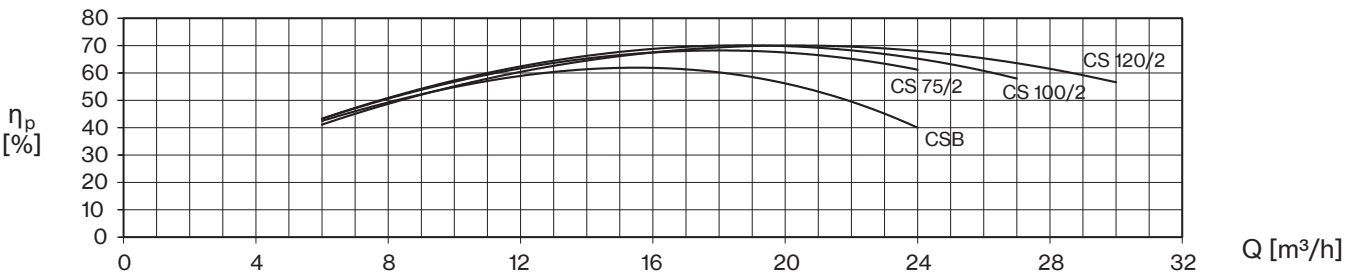
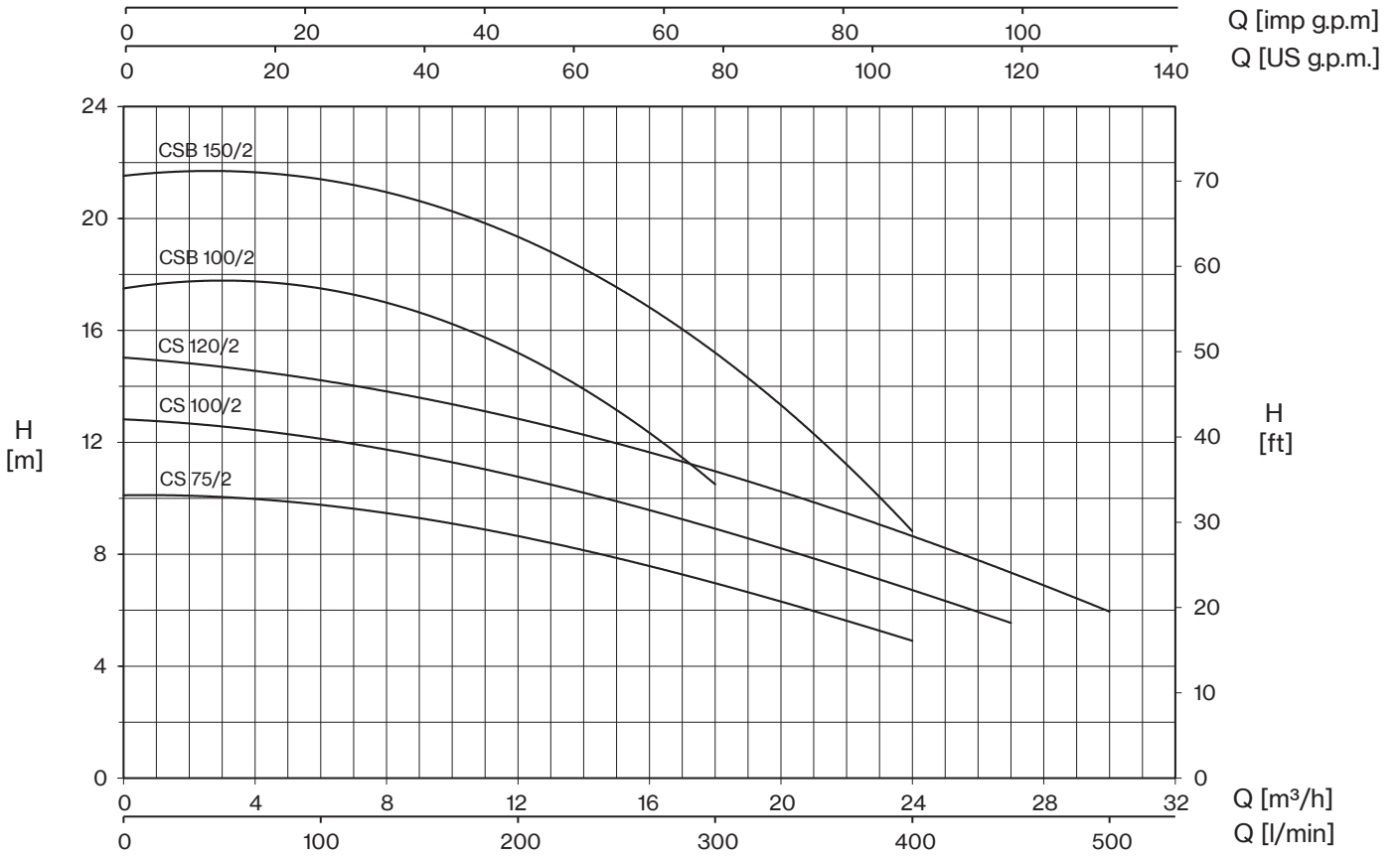

TYPE		P2		P1 (kW)		AMPERE		Q (m³/h - l/min)						
1~	3~					1~	3~	0	6	12	18	24	27	30
		0	100	200	300			400	450	500				
		HP	kW	1~	3~	1x230 V 50 Hz	3x400 V 50 Hz	H (m)						
CS 75/2	CST 75/2	0,8	0,59	0,8	0,7	3,5	1,3	10,1	9,8	8,6	7,0	4,9		
CS 100/2	CST 100/2	1	0,74	1	0,85	4,5	1,6	12,8	12,2	10,7	8,9	6,8	5,5	
CS 120/2	CST 120/2	1,2	0,9	1,2	1,1	5,4	2,0	15,0	14,3	12,8	10,9	8,7	7,4	5,9
CSB 100/2	-	1	0,74	1,23	-	6,0	-	17,5	17,5	15,2	10,5			
CSB 150/2	CSBT 150/2	1,5	1,1	1,78	1,65	8,5	3,0	21,5	21,5	19,2	15,3	8,8		



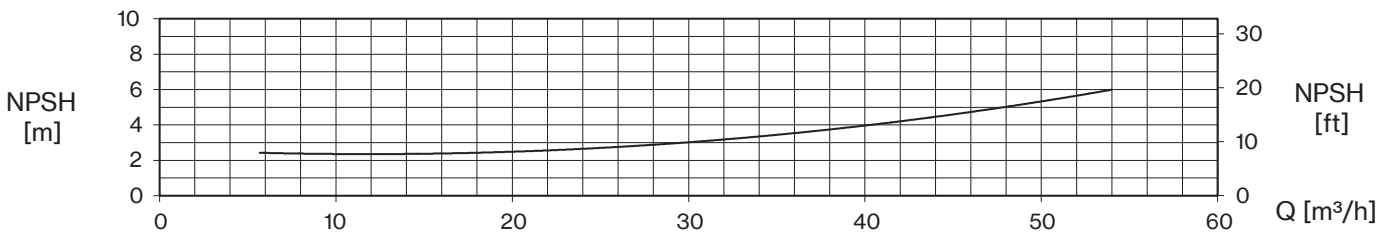
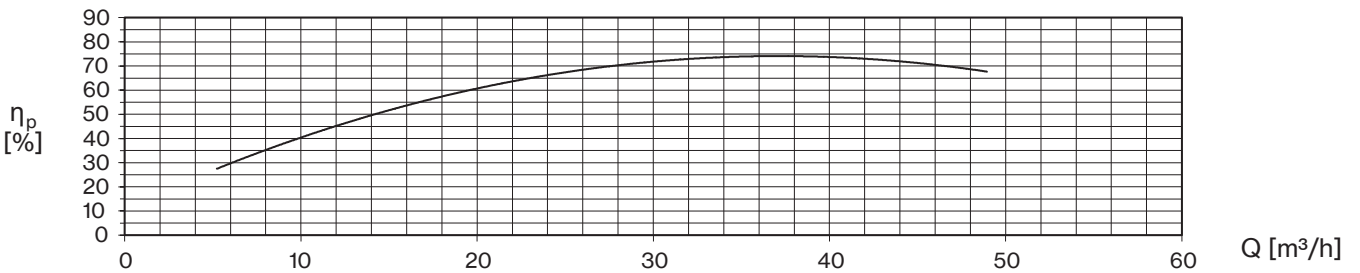
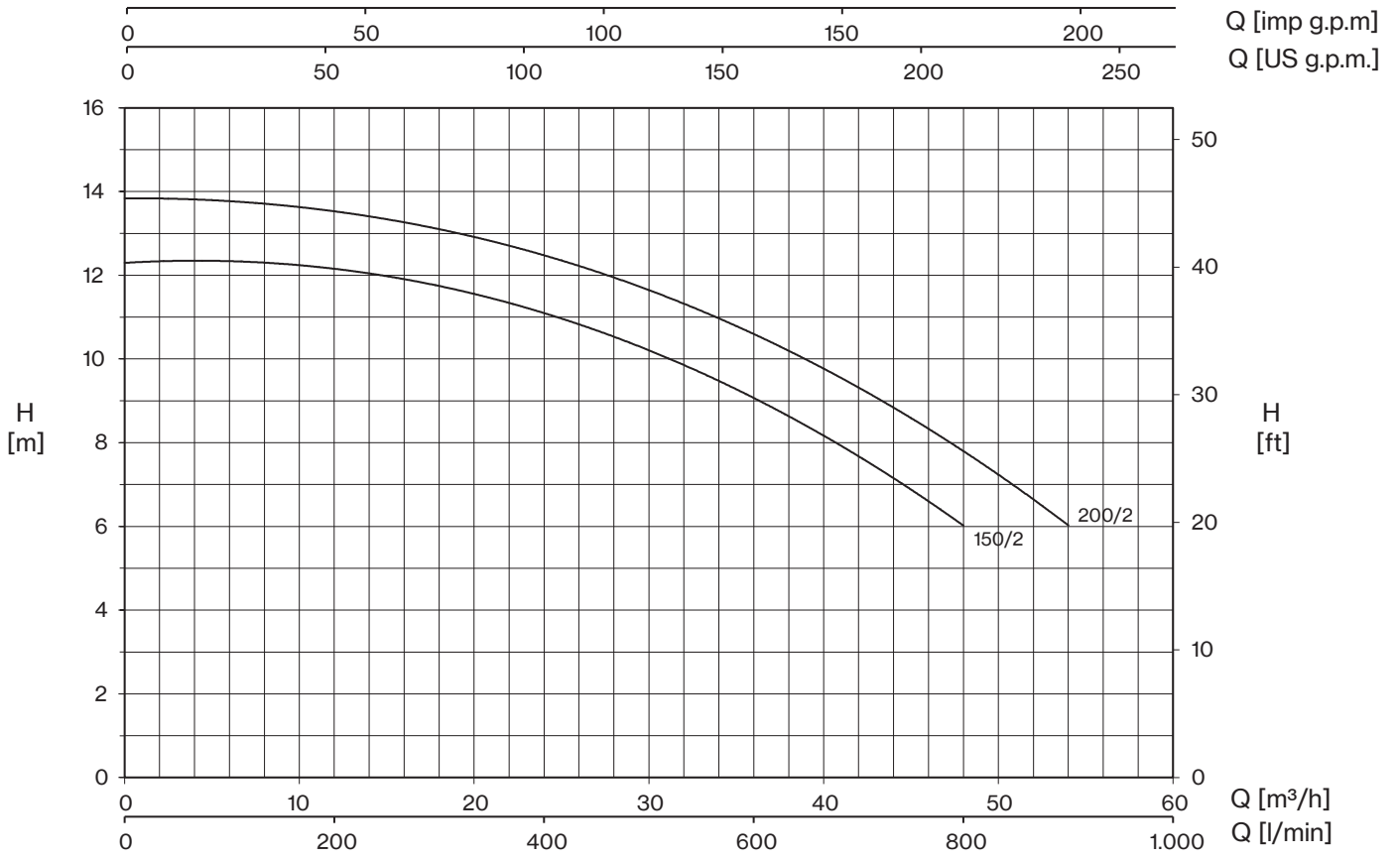

TYPE		P2		P1 (kW)		AMPERE		Q (m³/h - l/min)									
1~	3~					1~	3~	0	6	12	18	24	30	36	42	48	54
		0	100	200	300			400	500	600	700	800	900				
		HP	kW	1~	3~	1x230 V 50 Hz	3x400 V 50 Hz	H (m)									
CS 150/2	CST 150/2	1,5	1,1	1,85	1,8	8,8	3,3	12,3	12,3	12,2	11,8	11,0	10,2	9,1	7,7	6,0	
CS 200/2	CST 200/2	2	1,5	2,1	2,1	10,0	3,9	13,8	13,8	13,6	13,1	12,4	11,6	10,6	9,4	7,8	6,0



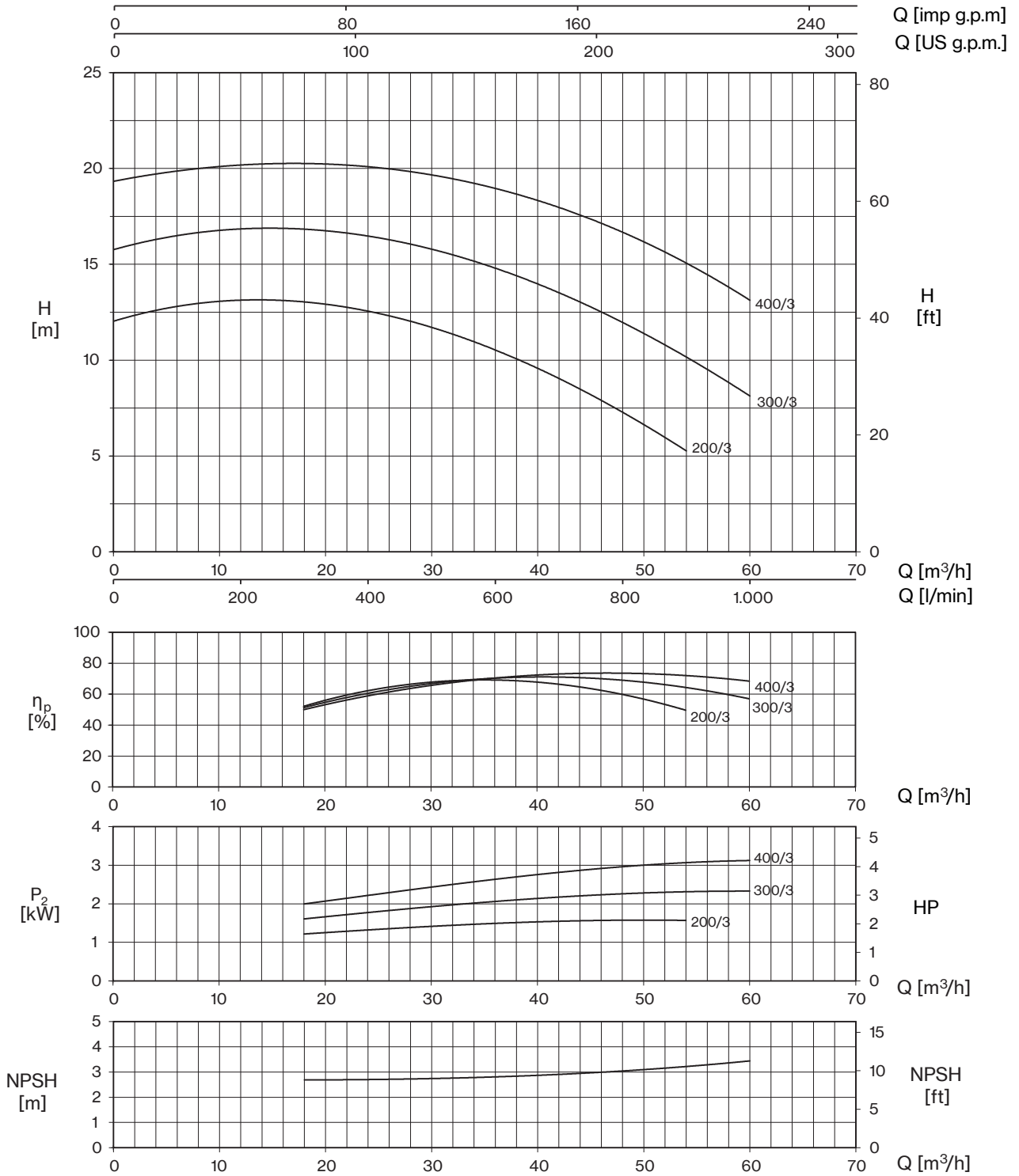

TYPE		P2		P1 (kW)		AMPERE		Q (m³/h - l/min)								
1~	3~	HP	kW	1~	3~	1~	3~	0	18	24	30	36	42	48	54	60
								0	300	400	500	600	700	800	900	1000
								H (m)								
						1x230 V 50 Hz	3x400 V 50 Hz									
CS 200/3	CST 200/3	2	1,5	1,9	1,9	8,9	3,5	12,0	13,0	12,6	11,8	10,6	9,0	7,2	5,3	
CS 300/3	CST 300/3	3	2,2	2,7	2,7	12,4	5	15,8	16,8	16,5	15,7	14,7	13,6	12,0	10,1	8,2
-	CST 400/3	4	3		3,6	-	6,6	19,3	20,3	20,1	19,6	18,9	18,0	16,8	15,0	13,1



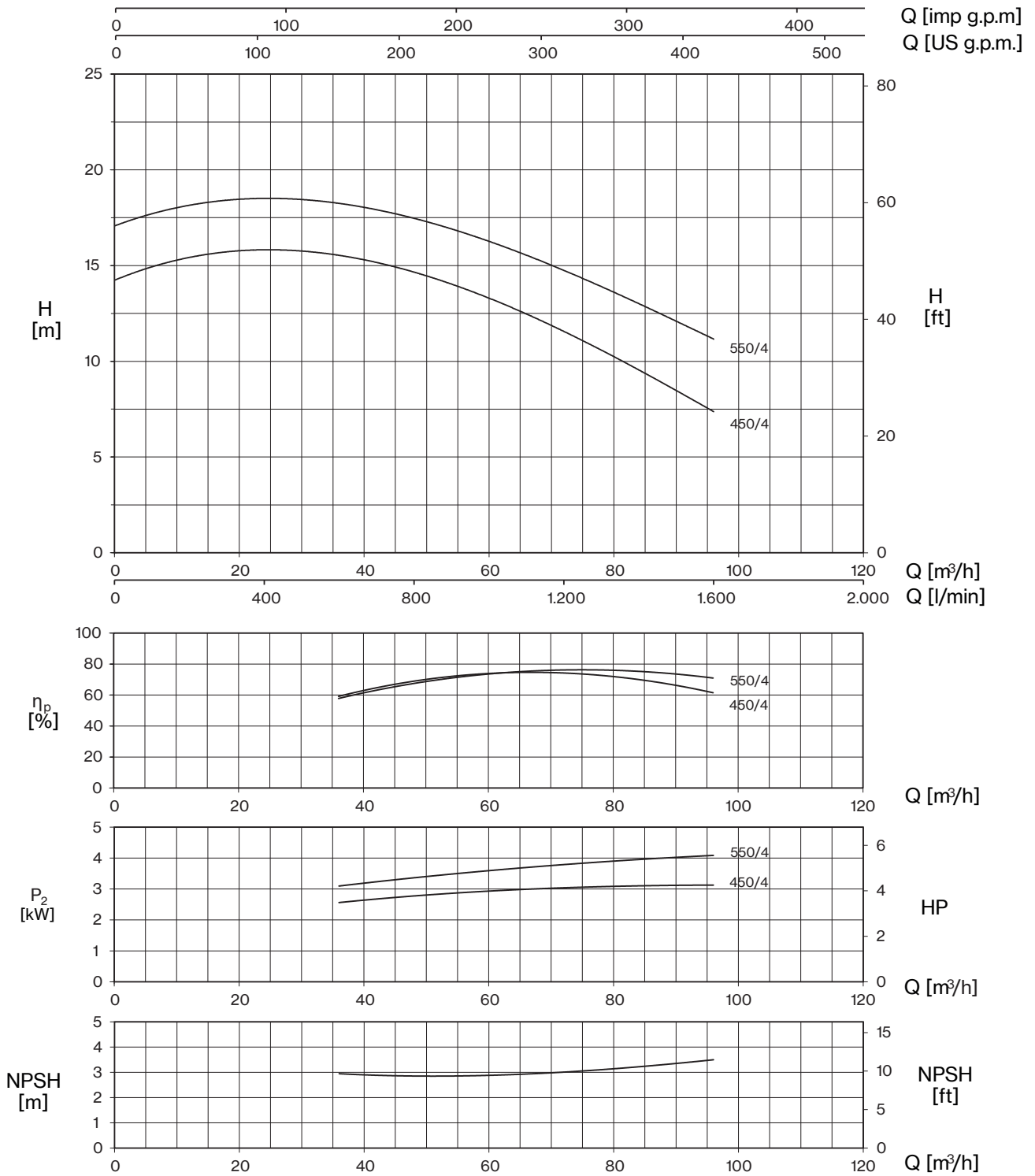

TYPE		P2		P1 (kW)		AMPERE		Q (m³/h - l/min)								
1~	3~	HP	kW	1~	3~	1~	3~	0	36	48	60	72	84	96		
								0	600	800	1000	1200	1400	1600		
						1x230 V 50 Hz		3x400 V 50 Hz		H (m)						
CS 450/4	CST 450/4	4	3	3,6	3,6	16,1	6,5	14,2	15,5	14,7	13,4	11,5	9,6	7,4		
-	CST 550/4	5,5	4	4,7	4,7	-	8,5	17,1	18,3	17,4	16,3	14,7	13,1	11,1		



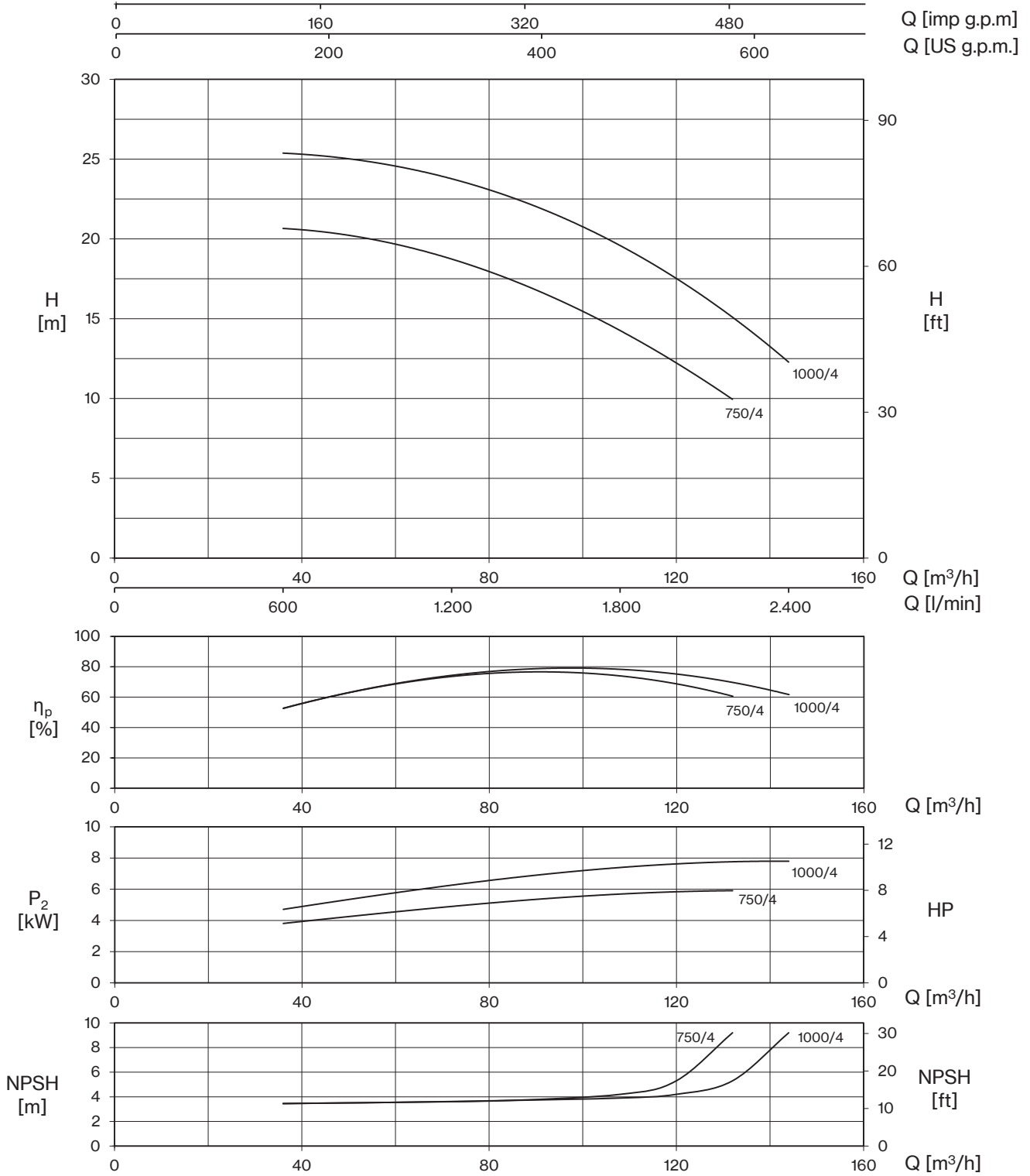



TYPE	P2		P1 (kW)	AMPERE	Q (m³/h - l/min)									
					0	36	48	60	84	108	120	132	144	
3~	HP	kW	3~	3x400 V 50 Hz	0	600	800	1000	1400	1800	2000	2200	2400	
					H (m)									
CST 750/4	7,5	5,5	6,7	11,6	18,9	20,6	20,4	19,7	17,4	14,3	12,3	9,9		
CST 1000/4	10	7,5	8,8	15,4	23,6	25,3	25,2	24,6	22,6	19,5	17,6	15,2	12,2	

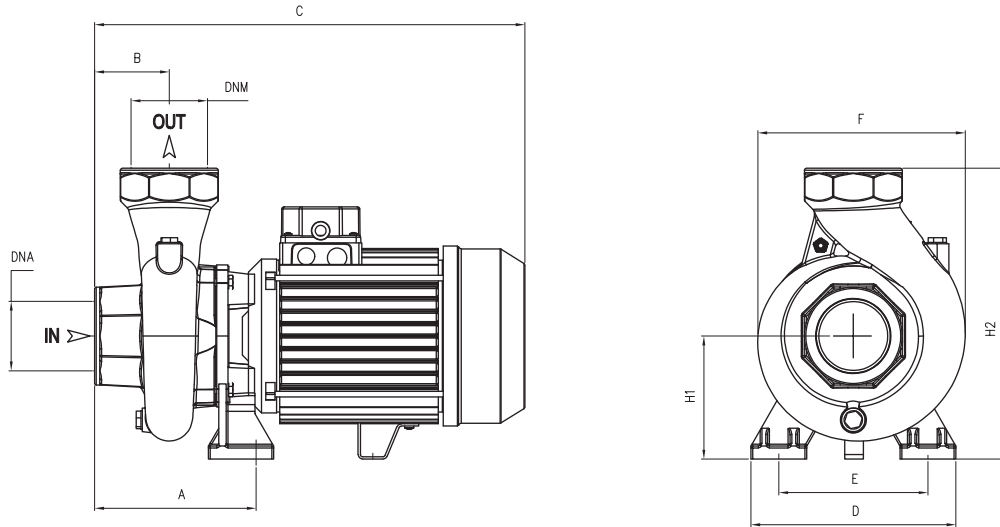



TYPE	DIMENSIONS (mm)																
	A	B	C	D	E	F	H1	H2	DNA	DNM	I	L	M	kg	T		
CS 75/2	127	45	315	155	115	178	97	247	2" G	2" G	340	195	280	14,5	T 14		
CS 100/2	127	45	315	155	115	178	97	247			340	195	280	16	T 25		
CS 120/2	127	45	315	155	115	178	97	247			340	195	280	16,5	T 16		
CSB 100/2	130	70	365	180	130	195	90	240	2" G	2" G	390	230	325	19	T 19		
CSB 150/2	130	70	365	180	130	195	90	240			390	230	325				
CS 150/2	150	53	370	180	140	218	115	285			390	230	325			24,5	T 23,5
CS 200/2	150	53	370	180	140	218	115	285	2" G	2" G	390	230	325	25	T 24,5		
CS 200/3	176,5	80	485	200	140	225	112	292			520	235	320	29	T 28		
CS 300/3	176,5	80	485	200	140	225	112	292			3" G	3" G	520	235	320	32,5	T 30
CST 400/3	176,5	80	485	200	140	225	112	292	3" G	3" G	520	235	320	32,5	T 30		
CS 450/4	165	85	515	220	160	250	130	330			546	265	355			46	T 42
CST 550/4	165	85	515	220	160	250	130	330			4" G	4" G	546			265	355
CST 750/4	117	83	559	215	170	254	134	333	4" G	4" G	675	390	300	56,5	T 42		
CST 1000/4	117	83	559	215	170	254	134	333			675	390	300	63	T 42		